

The RS-232/DALI Bridge Interface

Author: Ross Fosler
Microchip Technology Inc.

INTRODUCTION

The Digitally Addressable Lighting Interface (DALI) has emerged as a standard in Europe to address growing power issues. DALI is known as Annex E of the European electronic ballast standard EN60929 and specifically relates to digitally controlled dimmable ballasts. DALI type ballasts can run at lower power levels than standard magnetic ballasts. With the rise of digitally controlled ballasts, the need for devices that 'talk' to them has increased as well. This application note describes a very simple interface between the RS-232 serial port (available on almost all computers) and DALI, where the PIC16F628 is the core of the interface. The methods and circuits introduced here can be expanded upon to develop more enhanced DALI master control systems.

FIGURE 1: RS-232/DALI BRIDGE

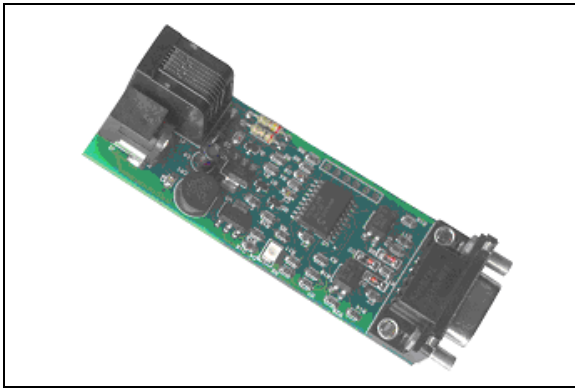

BRIDGING BETWEEN THE TWO INTERFACES

The RS-232/DALI Bridge is a simple translator that transfers data from RS-232 to DALI and vice versa. The Bridge handles the specific interface and conversion requirements for both RS-232 and DALI. Figure 2 illustrates an elementary block view of the Bridge.

FIGURE 2: RS-232/DALI BRIDGE BLOCK DIAGRAM

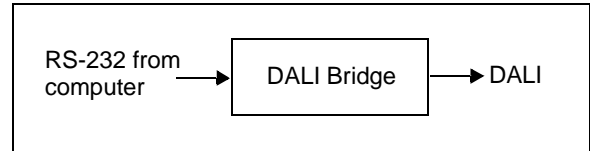

The RS-232 Forward Data Format

The Bridge is a command driven control, therefore, you must give the bridge a command to transfer the data to the Digitally Addressable Lighting Interface. It receives commands through the RS-232 interface. The data packet length is three bytes. The first byte is the command for the bridge. The second byte is the address information for the DALI device or devices. The third byte is the command information for the DALI device or devices. The format of the data received from the RS-232 serial port is shown in Figure 3.

FIGURE 3: FORWARD DATA FORMAT

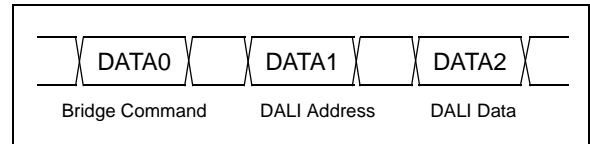

The RS-232 Backward Data Format

Data returned from the Digitally Addressable Lighting Interface is transferred through the RS-232 interface in a backward data format, which is different from the forward format. First, an acknowledge byte is transmitted and then a data byte. The acknowledge byte tells the computer if valid data was returned from the Digitally Addressable Lighting Interface. If valid data was returned, then the data is included in the return. Figure 4 illustrates the backward data format.

FIGURE 4: BACKWARD DATA FORMAT

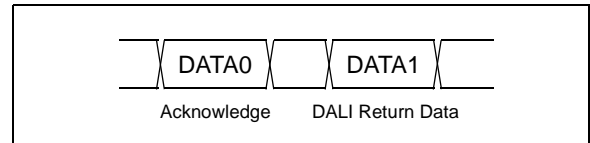

AN811

The DALI Forward Frame

The DALI forward frame is 19 bits long using Manchester encoding. The first bit is a start bit. The next sixteen bits are DALI address and command data. The last two are stop bits, which are not Manchester encoded. Figure 5 illustrates the DALI forward frame.

FIGURE 5: DALI Forward Frame

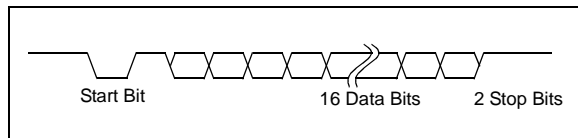

The DALI Backward Frame

The DALI backward frame looks very much like the forward frame with one exception. The backward frame passes only 8 bits of data. Figure 6 illustrates the DALI backward frame.

FIGURE 6: DALI Backward Frame

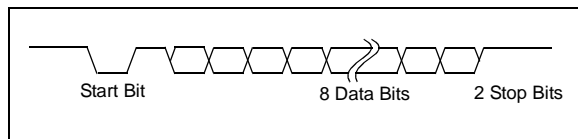

DALI Command Types

The three basic types of commands for DALI are standard commands, query commands and setup commands. The RS-232/DALI Bridge is programmed with commands to handle each of these three types of commands.

STANDARD COMMANDS

Standard commands are the most common commands. They are used to control arc power. Examples include 'GOTO SCENE LEVEL', 'RECALL MAX LEVEL', and 'STEP UP'. Standard commands are executed with one DALI forward frame. Command 16 of the RS-232/DALI Bridge is used to send standard commands to the Digitally Addressable Lighting Interface.

QUERY COMMANDS

Query commands provide information about the DALI ballast status or setup. Examples include 'QUERY MAX LEVEL', 'QUERY ACTUAL LEVEL', and 'QUERY STATUS'. These commands are executed with one forward frame. Upon execution, the ballast(s) returns data in a DALI backward frame within 9.17 ms. Command 18 on the Bridge is used to send query commands to the Digitally Addressable Lighting Interface.

SETUP COMMANDS

Setup commands are used to setup the ballast(s) on the Digitally Addressable Lighting Interface. Examples of setup commands include 'STORE THE DTR AS

MAX LEVEL', 'STORE THE DTR AS SCENE', and 'RESET'. These commands are executed by sending two identical DALI forward frames within 100 ms. Command 17 is used to send setup commands to the Digitally Addressable Lighting Interface.

ADDITIONAL BRIDGE COMMANDS

Beyond sending and receiving DALI commands, the RS-232/DALI Bridge has some other built in commands. These commands primarily focus on the Bridge functionality.

Bridge Status Information

Two pieces of status information about the bridge are available. The most important one is the overload status bit. This identifies if the Digitally Addressable Lighting Interface was shorted for more than 254 ms consecutively. The firmware automatically disables the DALI interface when this event occurs. The second status bit identifies if the bridge actually received data (Bridge command 18). If data was expected, but not received, then this bit is asserted.

Bridge Configuration

There are several commands used to fine-tune the bridge. These commands relate to transmit and receive timings, regulator delays, and command delays. Appendix A identifies all the existing commands corresponding to the firmware. Please refer to source code on our web site at (www.microchip.com).

THE RS-232 INTERFACE

The RS-232 serial interface serves two major purposes. One purpose is to transfer the data from the computer to the Bridge and vice versa. The second purpose is to protect the computer from unexpected high transient voltages. The computer is far more costly to replace than the Bridge.

Isolation

Complimentary circuitry is provided to interface the RS-232 serial connections to the PIC16F628. Essentially, this circuitry is optical isolation, which protects the computer from serious damage, since the Bridge is connected to one or more ballasts. Ballasts typically have running voltages 20 to 40 times greater than the computer serial port logic. Voltages at this level could easily damage the computer. On the RS-232 side, the isolation circuit is powered by the signals of the standard RS-232 serial port. The particular signals providing power are TX, RTS, and DTR. The isolation on the PIC16F628 side is powered by the connected power source. The complete circuit showing the isolation and power requirements is provided in Appendix B.

Transmitting and Receiving

Transmitting and receiving data is very convenient. The design incorporates the use of the USART module built into the PIC16F628. Therefore, all RS-232 serial communications is handled by the hardware on the chip. This allows for simpler firmware.

THE DIGITALLY ADDRESSABLE LIGHTING INTERFACE

DALI is a master-slave type system, which means the slave (ballast) only responds when commanded to. Each ballast responds by sinking the current carried through the two-wire interface, which drops the potential across the two-wire interface. The master (Bridge) provides current regulation to 250mA. Therefore, the master transmits data by raising or lowering the voltage across the two-wire interface. The responding slave transmits data by sinking 250mA of current provided by the master. All data is Manchester encoded. Refer to Appendix B for the circuit design.

Current Regulation

Current regulation of 250mA is provided using one of the comparators built into the PIC16F628. The comparator compares a reference voltage to the voltage across a current sense resistor. This provides the negative feedback. The digital output of the comparator is filtered to supply an analog voltage to the load-driving transistor. This puts the load-driving transistor into its active region. Since the comparator is controlled within the PIC16F628, the regulation can be enabled and disabled as necessary. This feature is particularly useful to prevent circuit failure if the Digitally Addressable Lighting Interface becomes shorted indefinitely. It is also useful to disable regulation when transmitting. Regulation is required for the master to receive data.

Transmitting

The load-driving transistor used for regulation is also used for data transmission; however, the regulation is disabled. The load-driving transistor is switched on or off by the PIC16F628, depending on the data being sent. An additional transistor is switched on or off 180 degrees out of phase. This transistor pulls the data line low when the load-driving transistor is off. Thus data is transmitted using a push-pull transistor configuration. The firmware handles the data transmission.

Receiving

The second comparator in the PIC16F628 is used for receiving data. The reference for this comparator is set slightly below the ripple of the current regulator. When the slave (ballast) is transmitting, the regulator is switching between 250mA of regulation and no regulation. Thus, the data receiving comparator output will always be asserted when regulation is occurring. The

PIC16F628 uses this bit information as the incoming data. The firmware receives these bits of data and compiles them into a useful format.

MEMORY USAGE

The firmware shown on our web site at (www.microchip.com) was built for the PIC16F628. Table 1 provides the percentage used of all the memory types.

TABLE 1: MEMORY PERCENTAGES

Memory Type	Max	Used	% Used
Program	2181	929	42.60
Data	224	42	18.75
EE Data	128	17	13.28

CONCLUSION

The RS-232/DALI Bridge is an example of a simple Digitally Addressable Lighting Interface master device. It performs the required functions that a master device is expected to do on DALI. The basic circuitry and firmware implemented here is a very good starting point for a much more sophisticated or 'smarter' master control.

AN811

APPENDIX A: RS-232/DALI BRIDGE COMMANDS

TABLE A-1: RS-232/DALI BRIDGE COMMANDS

Command	Function	DATA1	DATA2
0	Reset the Bridge	NA	NA
1	Return the status of the Bridge, Bit 1 = receive error, Bit 2 = DALI Bus Overload	NA	NA
8	Store first DALI 16-bit sequence, (Command 19)	DALI MSB	DALI LSB
9	Store second DALI 16-bit sequence, (Command 19)	DALI MSB	DALI LSB
10	Store third DALI 16-bit sequence, (Command 19)	DALI MSB	DALI LSB
16	Send, send 16-bit DALI sequence	DALI MSB	DALI LSB
17	Double Send, send 16-bit DALI sequence twice at 10 ms apart	DALI MSB	DALI LSB
18	Send & Receive, send 16-bit DALI sequence and wait at most 100 ms for an 8-bit return	DALI MSB	DALI LSB
19	Send the three word sequence from commands 8, 9, & 10	NA	NA
192	Change DALI TX edge delay (us)	DATA_H	DATA_L
193	Change DALI TX stop delay (us)	DATA_H	DATA_L
194	Change DALI bridge regulator delay (us)	DATA_H	DATA_L
195	Change DALI RX wait (ms) (Command 18)	NA	DATA_L
196	Change DALI RX start delay (us)	DATA_H	DATA_L
197	Change DALI RX sample delay (us)	DATA_H	DATA_L
198	Change DALI RX sample end delay (us)	DATA_H	DATA_L
199	Enable debug	NA	DATA_L
200	Change DALI double send delay (ms) (Command 17)	NA	DATA_L
201	Change DALI sequence delay (ms) (Command 19)	NA	DATA_L
208	Query DALI TX edge delay MSB	NA	NA
209	Query DALI TX edge delay LSB	NA	NA
210	Query DALI TX stop delay MSB	NA	NA
211	Query DALI TX stop delay LSB	NA	NA
212	Query DALI bridge regulator delay MSB	NA	NA
213	Query DALI bridge regulator delay LSB	NA	NA
214	Query DALI RX wait	NA	NA
215	Query DALI RX start delay MSB	NA	NA
216	Query DALI RX start delay LSB	NA	NA
217	Query DALI RX sample delay MSB	NA	NA
218	Query DALI RX sample delay LSB	NA	NA
219	Query DALI RX sample end delay MSB	NA	NA
220	Query DALI RX sample end delay LSB	NA	NA
221	Query debug	NA	NA
222	Query DALI double send delay	NA	NA
223	Query DALI sequence delay	NA	NA

APPENDIX B: THE CIRCUIT

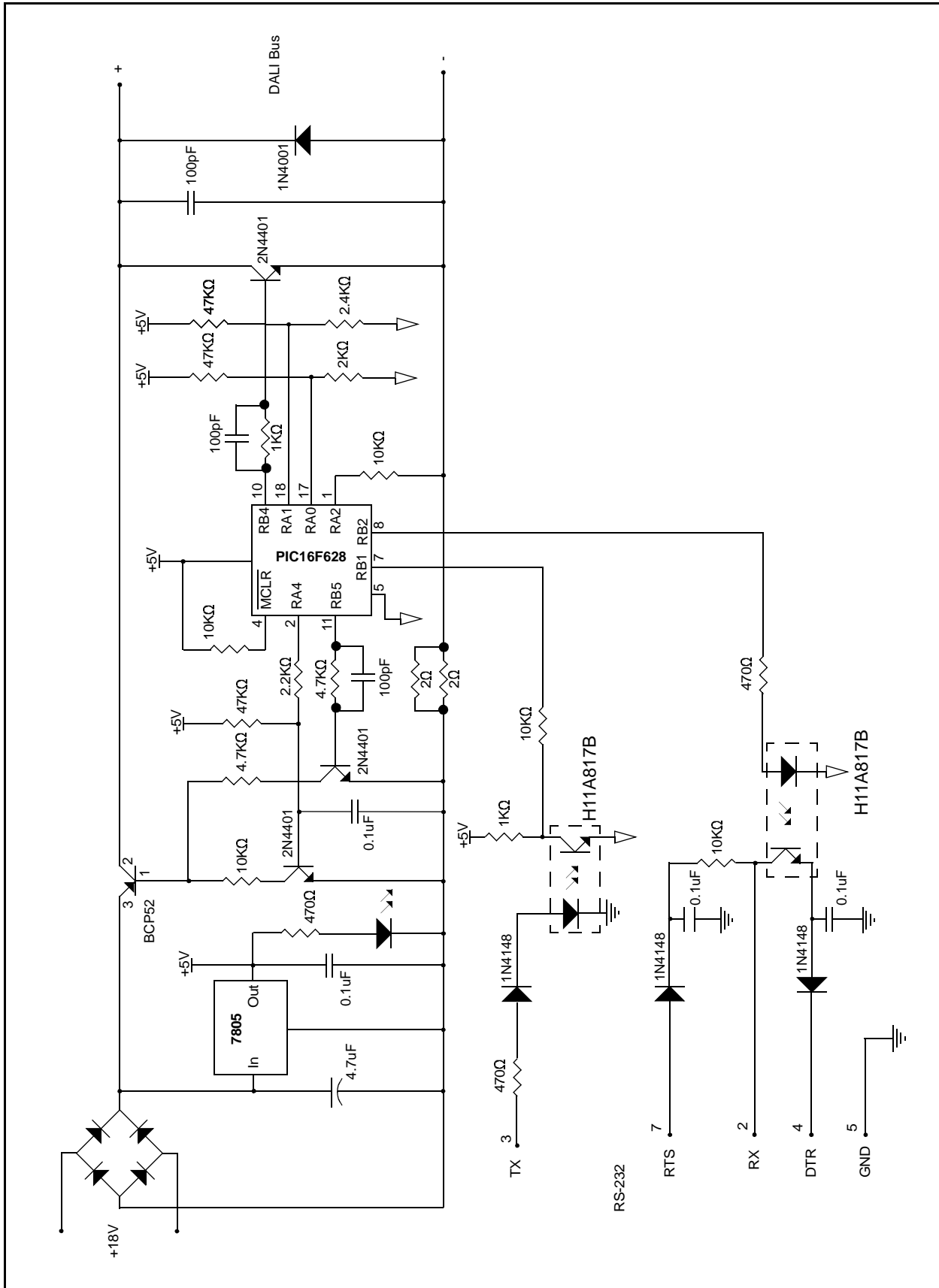

AN811

NOTES:

Note the following details of the code protection feature on PICmicro® MCUs.

- The PICmicro family meets the specifications contained in the Microchip Data Sheet.
- Microchip believes that its family of PICmicro microcontrollers is one of the most secure products of its kind on the market today, when used in the intended manner and under normal conditions.
- There are dishonest and possibly illegal methods used to breach the code protection feature. All of these methods, to our knowledge, require using the PICmicro microcontroller in a manner outside the operating specifications contained in the data sheet. The person doing so may be engaged in theft of intellectual property.
- Microchip is willing to work with the customer who is concerned about the integrity of their code.
- Neither Microchip nor any other semiconductor manufacturer can guarantee the security of their code. Code protection does not mean that we are guaranteeing the product as “unbreakable”.
- Code protection is constantly evolving. We at Microchip are committed to continuously improving the code protection features of our product.

If you have any further questions about this matter, please contact the local sales office nearest to you.

Information contained in this publication regarding device applications and the like is intended through suggestion only and may be superseded by updates. It is your responsibility to ensure that your application meets with your specifications. No representation or warranty is given and no liability is assumed by Microchip Technology Incorporated with respect to the accuracy or use of such information, or infringement of patents or other intellectual property rights arising from such use or otherwise. Use of Microchip's products as critical components in life support systems is not authorized except with express written approval by Microchip. No licenses are conveyed, implicitly or otherwise, under any intellectual property rights.

Trademarks

The Microchip name and logo, the Microchip logo, FilterLab, KEELOQ, microID, MPLAB, PIC, PICmicro, PICMASTER, PICSTART, PRO MATE, SEEVAL and The Embedded Control Solutions Company are registered trademarks of Microchip Technology Incorporated in the U.S.A. and other countries.

dsPIC, ECONOMONITOR, FanSense, FlexROM, fuzzyLAB, In-Circuit Serial Programming, ICSP, ICEPIC, microPort, Migratable Memory, MPASM, MPLIB, MPLINK, MPSIM, MXDEV, PICC, PICDEM, PICDEM.net, rfPIC, Select Mode and Total Endurance are trademarks of Microchip Technology Incorporated in the U.S.A.

Serialized Quick Turn Programming (SQTP) is a service mark of Microchip Technology Incorporated in the U.S.A.

All other trademarks mentioned herein are property of their respective companies.

© 2002, Microchip Technology Incorporated, Printed in the U.S.A., All Rights Reserved.

 Printed on recycled paper.

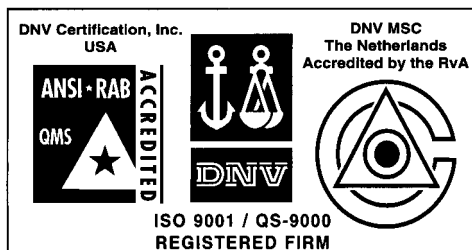

Microchip received QS-9000 quality system certification for its worldwide headquarters, design and wafer fabrication facilities in Chandler and Tempe, Arizona in July 1999 and Mountain View, California in March 2002. The Company's quality system processes and procedures are QS-9000 compliant for its PICmicro® 8-bit MCUs, KEELOQ® code hopping devices, Serial EEPROMs, microperipherals, non-volatile memory and analog products. In addition, Microchip's quality system for the design and manufacture of development systems is ISO 9001 certified.



WORLDWIDE SALES AND SERVICE

AMERICAS

Corporate Office

2355 West Chandler Blvd.
Chandler, AZ 85224-6199
Tel: 480-792-7200 Fax: 480-792-7277
Technical Support: 480-792-7627
Web Address: <http://www.microchip.com>

Rocky Mountain

2355 West Chandler Blvd.
Chandler, AZ 85224-6199
Tel: 480-692-7966 Fax: 480-792-7456

Atlanta

500 Sugar Mill Road, Suite 200B
Atlanta, GA 30350
Tel: 770-640-0034 Fax: 770-640-0307

Boston

2 Lan Drive, Suite 120
Westford, MA 01886
Tel: 978-692-3848 Fax: 978-692-3821

Chicago

333 Pierce Road, Suite 180
Itasca, IL 60143
Tel: 630-285-0071 Fax: 630-285-0075

Dallas

4570 Westgrove Drive, Suite 160
Addison, TX 75001
Tel: 972-818-7423 Fax: 972-818-2924

Detroit

Tri-Atria Office Building
32255 Northwestern Highway, Suite 190
Farmington Hills, MI 48334
Tel: 248-538-2250 Fax: 248-538-2260

Kokomo

2767 S. Albright Road
Kokomo, Indiana 46902
Tel: 765-864-8360 Fax: 765-864-8387

Los Angeles

18201 Von Karman, Suite 1090
Irvine, CA 92612
Tel: 949-263-1888 Fax: 949-263-1338

New York

150 Motor Parkway, Suite 202
Hauppauge, NY 11788
Tel: 631-273-5305 Fax: 631-273-5335

San Jose

Microchip Technology Inc.
2107 North First Street, Suite 590
San Jose, CA 95131
Tel: 408-436-7950 Fax: 408-436-7955

Toronto

6285 Northam Drive, Suite 108
Mississauga, Ontario L4V 1X5, Canada
Tel: 905-673-0699 Fax: 905-673-6509

ASIA/PACIFIC

Australia

Microchip Technology Australia Pty Ltd
Suite 22, 41 Rawson Street
Epping 2121, NSW
Australia
Tel: 61-2-9868-6733 Fax: 61-2-9868-6755

China - Beijing

Microchip Technology Consulting (Shanghai)
Co., Ltd., Beijing Liaison Office
Unit 915
Bei Hai Wan Tai Bldg.
No. 6 Chaoyangmen Beidajie
Beijing, 100027, No. China
Tel: 86-10-85282100 Fax: 86-10-85282104

China - Chengdu

Microchip Technology Consulting (Shanghai)
Co., Ltd., Chengdu Liaison Office
Rm. 2401, 24th Floor,
Ming Xing Financial Tower
No. 88 TIDU Street
Chengdu 610016, China
Tel: 86-28-6766200 Fax: 86-28-6766599

China - Fuzhou

Microchip Technology Consulting (Shanghai)
Co., Ltd., Fuzhou Liaison Office
Unit 28F, World Trade Plaza
No. 71 Wusi Road
Fuzhou 350001, China
Tel: 86-591-7503506 Fax: 86-591-7503521

China - Shanghai

Microchip Technology Consulting (Shanghai)
Co., Ltd.
Room 701, Bldg. B
Far East International Plaza
No. 317 Xian Xia Road
Shanghai, 200051
Tel: 86-21-6275-5700 Fax: 86-21-6275-5060

China - Shenzhen

Microchip Technology Consulting (Shanghai)
Co., Ltd., Shenzhen Liaison Office
Rm. 1315, 13/F, Shenzhen Kerry Centre,
Renminnan Lu
Shenzhen 518001, China
Tel: 86-755-2350361 Fax: 86-755-2366086

Hong Kong

Microchip Technology Hongkong Ltd.
Unit 901-6, Tower 2, Metroplaza
223 Hing Fong Road
Kwai Fong, N.T., Hong Kong
Tel: 852-2401-1200 Fax: 852-2401-3431

India

Microchip Technology Inc.
India Liaison Office
Divyasree Chambers
1 Floor, Wing A (A3/A4)
No. 11, O'Shaugnessey Road
Bangalore, 560 025, India
Tel: 91-80-2290061 Fax: 91-80-2290062

Japan

Microchip Technology Japan K.K.
Benex S-1 6F
3-18-20, Shinyokohama
Kohoku-Ku, Yokohama-shi
Kanagawa, 222-0033, Japan
Tel: 81-45-471-6166 Fax: 81-45-471-6122

Korea

Microchip Technology Korea
168-1, Youngbo Bldg. 3 Floor
Samsung-Dong, Kangnam-Ku
Seoul, Korea 135-882
Tel: 82-2-554-7200 Fax: 82-2-558-5934

Singapore

Microchip Technology Singapore Pte Ltd.
200 Middle Road
#07-02 Prime Centre
Singapore, 188980
Tel: 65-6334-8870 Fax: 65-6334-8850

Taiwan

Microchip Technology Taiwan
11F-3, No. 207
Tung Hua North Road
Taipei, 105, Taiwan
Tel: 886-2-2717-7175 Fax: 886-2-2545-0139

EUROPE

Denmark

Microchip Technology Nordic ApS
Regus Business Centre
Lautrup høj 1-3
Ballerup DK-2750 Denmark
Tel: 45 4420 9895 Fax: 45 4420 9910

France

Microchip Technology SARL
Parc d'Activite du Moulin de Massy
43 Rue du Saule Trapu
Batiment A - 1er Etage
91300 Massy, France
Tel: 33-1-69-53-63-20 Fax: 33-1-69-30-90-79

Germany

Microchip Technology GmbH
Gustav-Heinemann Ring 125
D-81739 Munich, Germany
Tel: 49-89-627-144 0 Fax: 49-89-627-144-44

Italy

Microchip Technology SRL
Centro Direzionale Colleoni
Palazzo Taurus 1 V. Le Colleoni 1
20041 Agrate Brianza
Milan, Italy
Tel: 39-039-65791-1 Fax: 39-039-6899883

United Kingdom

Arizona Microchip Technology Ltd.
505 Eskdale Road
Winnersh Triangle
Wokingham
Berkshire, England RG41 5TU
Tel: 44 118 921 5869 Fax: 44-118 921-5820

03/01/02