

Design Note:

HFDN-23.0

Rev.2; 04/08

Choosing the APC Loop Capacitors Used with MAX3735/MAX3735A SFP Module Designs

Choosing the APC Loop Capacitors Used with MAX3735 and MAX3735A SFP Module Designs

1 Introduction

The MAX3735 and MAX3735A are DC-coupled SFP laser drivers designed for data rates up to 2.7Gbps (Reference 1). The DC-coupled output, SFP safety/timing specifications and monitor outputs of the MAX3735/MAX3735A make these devices suitable for a large variety of optical module applications operating over a wide range of data rates.

The proper choice of the APC (Automatic Power Control) loop capacitors is critical for SFP and multi-rate designs using the MAX3735/MAX3735A laser drivers. If the capacitor is not chosen correctly, instability, increased jitter, or increased turn-on time (T_{ON}) may result.

This application note is intended to aid module designers in choosing proper values for the APC loop capacitors. Tables for MAX3735A C_{APC} selection are provided along with equations and a Microsoft® Excel spreadsheet for the calculations of the MA3735 loop capacitors.

2 Background Information

2.1 APC Loops

The APC loop integrated with many of Maxim's laser drivers is used to compensate for changes in threshold current due to variations in temperature and laser life. An APC loop (Figure 1) monitors the laser back-facet photodiode current and adjusts the bias current in order to keep the photodiode current constant. Given that the relationship between the photodiode current and average power is ideally linear, the average power is held constant by keeping the photodiode current at a constant level.

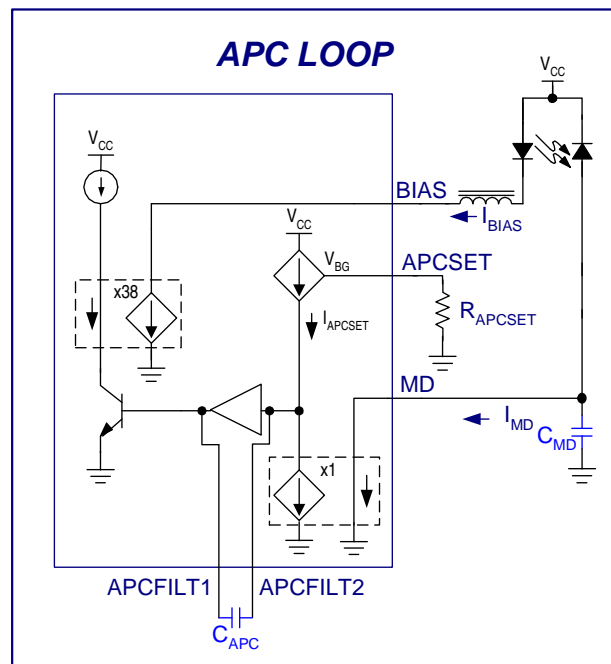

Figure 1. Typical APC loop

The bandwidth of the back-facet photodiode is generally smaller than the bandwidth of the laser that is being modulated due to capacitance of the photodiode. Therefore, the back-facet photodiode will not track all the high frequency changes in the optical output. The APC loop capacitors (C_{APC} and C_{MD}) filter the incoming signal further to suppress high-speed variations in the monitor diode current that are caused by variations in the bit pattern.

The C_{MD} capacitor sets the higher order pole that filters incoming transients on the monitor diode input pin. The C_{APC} capacitor sets the dominant pole of the APC loop and also determines the APC loop bandwidth (f_{3dB} , Figure 2). As C_{APC} increases, the APC loop bandwidth decreases.

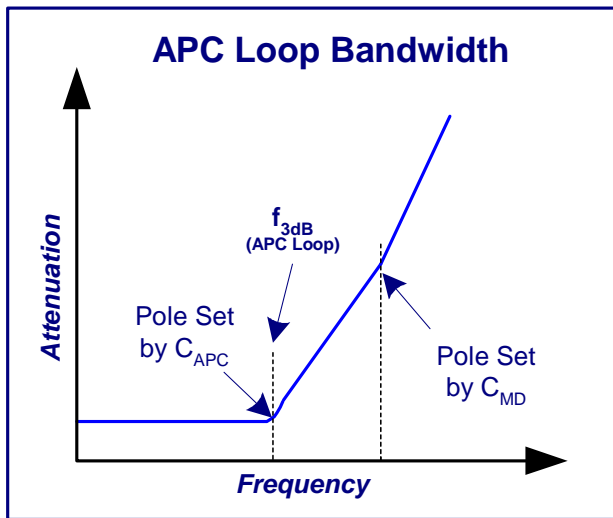

Figure 2. APC loop bandwidth

Monitor diode current variations at frequencies higher than f_{3dB} are attenuated by the loop capacitors. When the monitor diode current changes at a frequency less than f_{3dB} , the APC loop will track and adjust the bias current to force the monitor diode current to a constant level.

Low frequency variations of the monitor diode current can be due to factors such as temperature and age of the laser. As the temperature and age increase, more bias current is required to maintain the same monitor diode current (i.e. average power). The APC loop is designed and intended to compensate for these types of low frequency variations. For more information see references [2](#) and [3](#).

2.2 Frequency Content of Data Patterns

The frequency content of the input data pattern should be considered when choosing the APC loop capacitors. Ethernet application for example use coded patterns, such as 8b10b, that have very little low frequency content. SONET PRBS test patterns ($2^{23}-1$) and random NRZ data streams have a much fuller and wider frequency spectrum that can extend to very low frequencies (References [4](#), [5](#), [6](#) and [7](#)).

If the frequency content of the data pattern is lower than or close to the f_{3dB} point of the APC loop, an undesirable effect known as baseline wander can occur. The effect on the output is similar to the baseline wander effect caused by the low frequency cutoff point of AC-coupling capacitors (References [5](#) and [6](#)). In both cases, there is increased jitter and

decreased vertical eye opening when the low frequency point is not chosen correctly.

To demonstrate how the APC loop is able to track only low frequency changes in the data pattern, the following tests were performed. First, a laser was modulated at a high data rate using a repeating 1010 pattern (Figure 3). The filtered monitor diode current and bias current were observed as well as the optical output signal using a real-time scope. The frequency content of the data pattern is much greater than the APC loop bandwidth. As seen in Figure 3, the bias and monitor diode current do not track the one and zero bits of the data pattern and the optical output waveform is not affected.

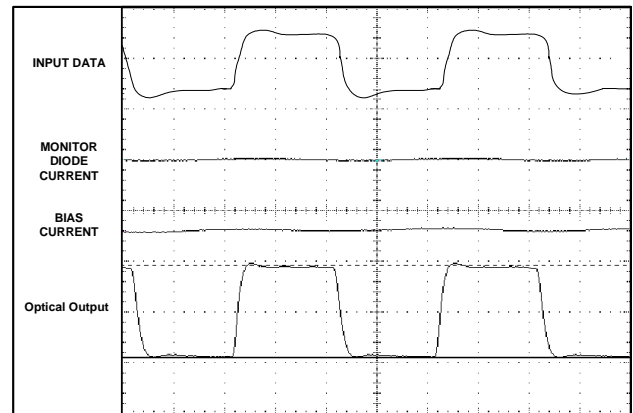

Figure 3. Input data with frequency content $\gg f_{3dB}$

As the data rate is decreased to a very low frequency (Figure 4), the filtered monitor diode current begins to track the data pattern transitions. The APC loop responds by increasing or decreasing the bias current to maintain the average power. The optical output is now affected due to the bias current variation created when the APC loop tracks the low frequency bit transitions of the low speed data pattern.

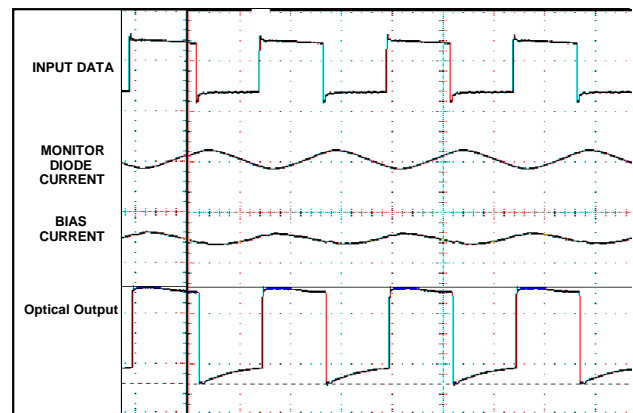

Figure 4. Input data with frequency content near f_{3dB}

Using a pseudo-random bit pattern, the baseline wander effect, due to the APC loop, can be seen with the optical eye diagram when infinite persistence is enabled. Figure 5 is a filtered OC3 optical eye diagram using the MAX3735 laser driver with a $2^{23}-1$ PRBS input data pattern. For this case, the APC loop bandwidth was purposely set at a high value. The low frequency content of the $2^{23}-1$ PRBS pattern at OC3 and the f_{3dB} point of the APC loop is not low enough which causes increased jitter and eye closure as seen in Figure 5.

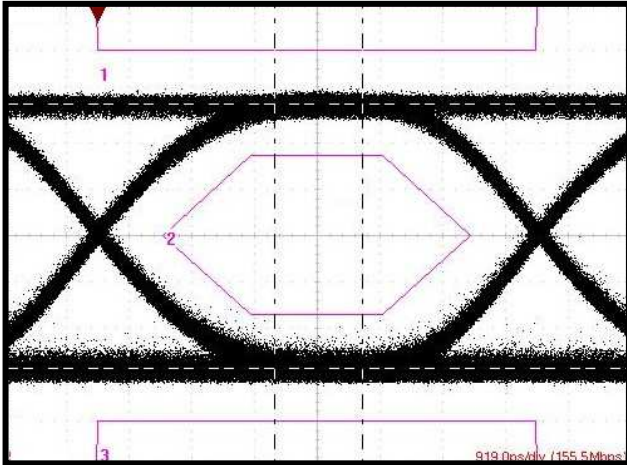

Figure 5. Optical eye – OC3, $2^{23}-1$ PRBS, $C_{APC} = 0.01\mu F$

By using a pattern with less low-frequency content or by using a larger APC loop capacitor, the optical results can be improved. As seen in figure 6, the eye opening and the jitter have both improved by using a larger C_{APC} capacitor.

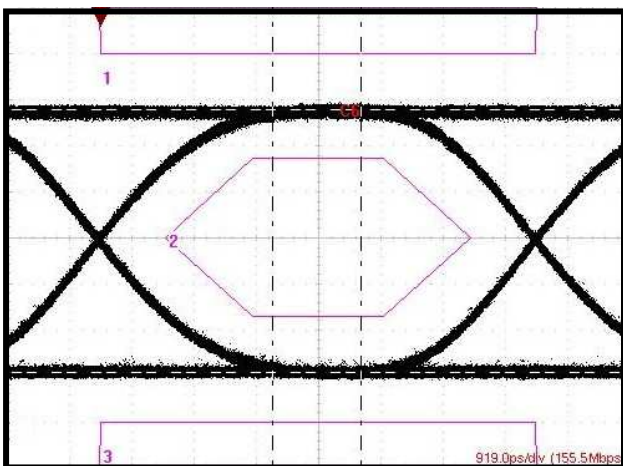

Figure 6. Optical eye – OC3, $2^{23}-1$ PRBS, $C_{APC} = 0.1\mu F$

The output of the MAX3735/MAX3735A is DC coupled which accommodates a wide modulation frequency range, but the effect of the APC loop must still be considered to obtain good performance for the entire range of data rates. Multi-rate applications that are intended to work from 100Mbps to 2.7Gbps have a wide frequency spectrum range that requires consideration of the input AC coupling (if used, see reference 6) and the APC loop capacitors. Both of which will have an effect on the overall baseline wander and jitter of the optical output. In particular, the lower data rates with long patterns may have increased jitter and eye closure when the APC loop's f_{3dB} point is not set properly with the loop capacitors.

To minimize the jitter and eye closure that can be associated with the low-frequency content of the data pattern, the f_{3dB} point of the APC loop should ideally be as low in frequency as possible by using a very large C_{APC} . This is not possible for all applications due to turn-on time requirements.

2.3 Turn-on Time (T_{ON})

The turn-on time (T_{ON} , See: SFP MSA) of the MAX3735 and MAX3735A is a function of the C_{APC} capacitor. In order to meet the SFP T_{ON} requirement of $\leq 1ms$, C_{APC} must be chosen correctly. Once the C_{APC} value is chosen to meet the T_{ON} requirement, the C_{MD} and the APC loop bandwidth can be determined. The APC loop bandwidth will help to establish the acceptable data rates and patterns that can be used and still maintain good optical performance.

If the intended application does not have a specification for T_{ON} , there is much more freedom in choosing the C_{APC} values that would minimize jitter due to baseline wander.

3 Choosing C_{APC} and C_{MD}

The T_{ON} requirement (if applicable to the application) should be the first variable to consider when choosing the APC loop capacitors. Guides to selecting C_{APC} based on T_{ON} requirements are listed below for the MAX3735A and MAX3735. The MAX3735A offers improved turn-on times under the same conditions and is the preferred device for multi-rate applications.

MAX3735A:

Table 1 can be used to choose C_{APC} when using the MAX3735A and a DC coupled laser, where laser gain is defined as:

$$Gain_{DC-Coupled} = \frac{I_{MD}}{(I_{BIAS} - I_{TH} + (I_{MOD} / 2))} (A/A)$$

C_{APC} should be chosen according to the highest gain of the lasers (generally at cold temperature). C_{MD} should then be 4x to 20x smaller than C_{APC}. The ratio between C_{APC} and C_{MD} should be maintained to separate the poles created by C_{APC} and C_{MD} capacitors and provide sufficient phase margin for loop stability.

Table 1. DC-Coupled C_{APC} Selection

Laser Gain (A/A)	C _{APC} (μF)	C _{MD} (μF)
0.005	0.039	0.0018 to 0.01
0.007	0.047	0.0022 to 0.012
0.010	0.068	0.0033 to 0.015
0.020	0.100	0.0047 to 0.022
0.030	0.120	0.0056 to 0.027
0.040	0.120	0.0056 to 0.027

The C_{APC} selection table assumes a 34% reduction in the gain of the lasers at 85°C from the cold values and that the Bias and MD current are within data sheet specifications.

If C_{APC} is selected as shown in the table, the loop bandwidth will be less than 17kHz and have turn on times less than 600uS. These features allow the device to be multi-rate and SFP compatible down to 155Mbps data rates using long patterns. See section 4 for more detail.

For AC-coupled laser, C_{APC} should be selected as shown in table 2. Where Gain is now defined as:

$$Gain_{AC-Coupled} = \frac{I_{MD}}{(I_{BIAS} - I_{TH})} (A/A)$$

Gain is a property of the laser, so it does not change if the laser is DC coupled or AC coupled to the driver. The affect it has on the loop is a result of the amount of bias current generated by the laser driver. For AC-coupled lasers the bias current will be larger because the modulation current does not contribute to the average current through the laser.

Since the MAX3735A minimum modulation current is 10mA, the minimum bias current is assumed to be at least 5mA for an AC-coupled laser. Given that the minimum BIAS current is 5mA, larger C_{APC} values can be used while still meeting turn-on times of less than 600us. For AC coupled lasers, C_{MD} should be 10x to 20x smaller than C_{APC}.

Table 2. AC-Coupled C_{APC} Selection

Laser Gain (A/A)	C _{APC} (μF)	C _{MD} (μF)
0.005	0.100	0.0047 to 0.01
0.007	0.120	0.0056 to 0.012
0.010	0.150	0.0068 to 0.015
0.020	0.150	0.0068 to 0.015
0.030	0.168	0.0082 to 0.017
0.040	0.180	0.0082 to 0.018

MAX3735:

To estimate the T_{ON} of the MAX3735, the equations in section 7 can be used. A Microsoft® Excel spreadsheet is also provided to help with the calculations (see section 8). The input parameters required by the user are indicated in **BLUE** and the output parameters from the equations are in **RED**.

Note that the equations assume that the laser is DC-coupled to the laser driver. The equations will give a worst-case estimation of the T_{ON} time given the provided information. An example in section 5 illustrates the procedure. Once C_{APC} is calculated to meet the T_{ON} time, C_{MD} can be easily calculated as approximately 20x smaller than C_{APC}.

4 Determining Acceptable Data Rates

From the data used to calculate the turn-on time, the bandwidth of the APC loop can also be approximated using the equations in section 7. The loop bandwidth equation is valid for both the MAX3735 and the MAX3735A. The loop bandwidth is a function of the C_{APC} capacitor and the gain (Figure 7), (defined in section 3). See section 7 for more details on calculating gain.

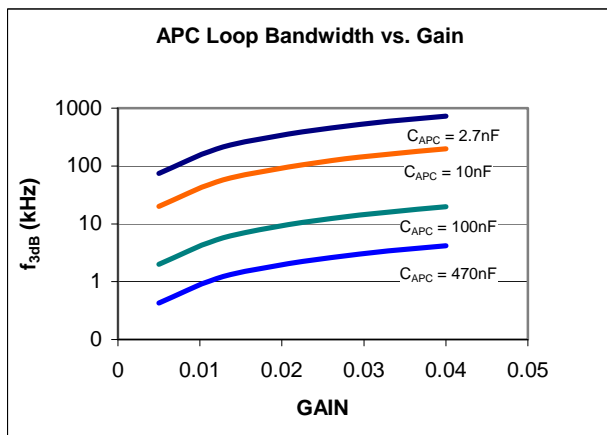

Figure 7. APC loop bandwidth vs. gain for various C_{APC} values.

Table 3 is provided to aid in determining acceptable data rates in multi-rate applications. This table was generated using baseline-wander calculations (Reference 5) with various loop bandwidths with a long ($2^{23}-1$) and a short (2^7-1) test pattern. The multi-rate range of operation can then be estimated as a maximum of approximately 2.7Gbps down to the minimum value listed in the table. Note that Table 3 assumes that the baseline wander effect due to AC-coupled data inputs (if used) is negligible. Data rates below 10Mbps were not considered.

Table 3. Loop Bandwidth vs. Data Rate

APC Loop Bandwidth f_{3dB} (kHz)	Minimum Data Rate (Mbps)	
	PRBS $2^{23}-1$	PRBS 2^7-1
795.8	-	320
502.4	-	200
316.7	-	125
199.9	2300	85
126.1	1500	55
79.6	925	35
50.2	600	21
31.7	375	14
20.0	240	10
12.6	145	10
8.0	100	10
5.0	60	10
3.2	40	10
2.0	25	10
1.3	15	10
0.8	10	10

Table 3 should be used as a starting point in choosing the acceptable data rates. The module designer should carefully consider the properties of

the entire system and determine what is acceptable performance in their application.

5 Example

An example of how to calculate the turn-on time and loop bandwidth of the MAX3735 and MAX3735A will be given. For these examples, the laser and module parameters are assumed to be as shown in Table 4.

Table 4. Module Parameters

Parameter	@ -40°C	@ 25°C	@ 85°C	Units
Slope Efficiency	0.024	0.022	0.016	mW/mA
Threshold Current	1.5	6	20	mA
Laser to Monitor Transfer	0.75	0.74	0.72	mA/mW
Modulation Current	30	40	50	mA
Extinction Ratio	10.4	10.4	10.4	dB

5.1 Example Calculation of T_{ON} (MAX3735A)

From the parameters listed in table 4, the gain was calculated to be largest at -40°C (0.018). Given the calculated gain of 0.018, C_{APC} was selected to be $0.100\mu\text{F}$ and C_{MD} was selected as $0.022\mu\text{F}$. This will allow for worst-case T_{ON} of approximately $600\mu\text{s}$ and will set the loop bandwidth to approximately 8.2kHz (From equations in section 7).

Comparing the loop bandwidth with table 3, acceptable performance can be obtained for data rates as low as 100Mbps using long PRBS patterns and less than 10Mbps when using shorter patterns (See Figure 6 and Table 3).

5.2 Example Calculation of T_{ON} (MAX3735)

The values from Table 4 were entered into the spreadsheet (see section 8) and result in the following turn-on times for various C_{APC} values (Table 5):

Table 5. T_{ON} Results with Various C_{APC} Values (MAX3735)

T _{ON} with:	@ -40°C	@ 25°C	@ 85°C	Units
C _{APC} = 0.01μF	161.6	58.6	28.3	μs
C _{APC} = 0.033μF	533.1	193.4	93.5	μs
C _{APC} = 0.047μF	759.3	275.5	133.1	μs
C _{APC} = 0.1μF	1615.6	586.2	283.3	μs

From the results shown in Table 5, it is apparent that the worst case is at cold temperature and that a 0.1μF capacitor should not be used if there is a T_{ON} requirement of 1ms. Note also that if the extinction ratio increases (by decreasing the bias current), the turn-on times would increase.

Calculations for the APC loop bandwidth (f_{3dB}) are also made by the spreadsheet with the following results (Table 6):

Table 6. Loop Bandwidth Results with Various C_{APC} Values (MAX3735)

f _{3dB} with:	@ -40°C	@ 25°C	@ 85°C	Units
C _{APC} = 0.01μF	82.09	73.5	50.24	kHz
C _{APC} = 0.033μF	24.87	22.27	15.22	kHz
C _{APC} = 0.047μF	17.46	15.64	10.69	kHz
C _{APC} = 0.1μF	8.09	7.35	5.02	kHz

As with the T_{ON} calculation, the worst-case condition (largest loop bandwidth) is at cold temperature. From Table 3 it is seen that using C_{APC} = 0.1μF, the device should be able to perform well at low data rates (≈ 100Mbps) with long or short patterns, while using a 0.01μF C_{APC} capacitor would limit the acceptable operation of the device to data rates greater than 1Gbps when using a long pattern. Under the given conditions, a 0.047μF C_{APC} capacitor should meet the T_{ON} requirement and also provide good performance at lower data rates (≈ 200Mbps) with long or short patterns.

6 Conclusion

Using the provided equations, the APC loop capacitors can be chosen to meet the SFP T_{ON} requirement and maintain loop stability. Given the capacitor values, the loop bandwidth and the corresponding usable data rates can then be determined.

7 Equations.

7.1 Turn-on Time (T_{ON}) and Loop Bandwidth (f_{3dB}):

MAX3735 Turn on Time Equation (DC Coupled Laser):

$$T_{ON} (\mu s) \approx \frac{(247.8 \cdot C_{APC} (\mu F))}{Gain \cdot (-0.0022 \cdot I_{TH}^2 + 0.2060 \cdot I_{TH} + 0.2928) \cdot (0.0018 \cdot X^3 - 0.0244 \cdot X^2 + 0.4667 \cdot X + 0.1947)}$$

MAX3735 and MAX3735A Loop Bandwidth Equation:

$$f_{3db}(kHz) \approx \frac{68.15 \cdot Gain^{1.1}}{C_{APC} (\mu F)}$$

Where I_{TH}, I_{MD}, I_{BIAS} and I_{MOD} are in units of mA and:

$$Gain = \frac{I_{MD}}{\left(I_{BIAS} - I_{TH} + \frac{I_{MOD}}{2} \right)} \quad X = \frac{I_{MOD}}{(r_e - 1)}$$

or

$$Gain = \eta \cdot \rho_{MON} \quad X = (I_{BIAS} - I_{TH})$$

7.2 Useful Optical Equations:

Parameter	Symbol	Relation / Definition
Average Power	P _{AVG}	$P_{AVG} = \frac{P_0 + P_1}{2}$
Extinction Ratio	r _e	$r_e = \frac{P_1}{P_0}$
Optical Amplitude	P _{P-P}	$P_{P-P} = P_1 - P_0$
Laser Slope Efficiency	η	$\eta = \frac{P_{P-P}}{I_{MOD}}$
Laser to Monitor Transfer	ρ _{MON}	$\rho_{MON} = \frac{I_{MD}}{P_{AVG}}$
Bias Current (DC-Coupled)	I _{BIAS}	$I_{BIAS} \geq I_{TH}$
Monitor Diode Current	I _{MD}	$I_{MD} = \rho_{MON} \cdot P_{AVG}$
Modulation Current	I _{MOD}	$I_{MOD} = \frac{P_{P-P}}{\eta}$

Note: All equations assume a DC-coupled laser and a 50% Mark Density

8 Excel® Spreadsheet

The following spreadsheet can be down loaded at:

<http://pdfserv.maxim-ic.com/arpdf/AppAttachments/1hfdn230.zip>

T_{ON} and APC Loop Bandwidth Calculator

Option 1 - Slope Efficiency & Laser to Monitor Transfer

Input Variables:

APC Loop Capacitor (C _{APC}):	0.1	μF
Modulation Current (I _{MOD}):	50	mA
Threshold Current (I _{TH}):	20	mA
Extinction Ratio (r _e):	10.4	dB
Slope Efficiency (η):	0.012	mW/mA
Laser to Monitor Transfer (ρ _{MON}):	0.65	mA/mW

Calculated Results:

Approx. Turn On Time (T _{ON}):	418.3558	μs
MD Filter Capacitor (C _{MD}):	5.000	nF
Approx. APC Loop Bandwidth (f _{3dB}):	3.27	kHz

Option 2 - Bias Current and Monitor Diode Current

Input Variables:

APC Loop Capacitor (C _{APC}):	0.033	μF
Modulation Current (I _{MOD}):	32	mA
Threshold Current (I _{TH}):	1.2	mA
Monitor Diode Current (I _{MD}):	0.275	mA
Bias Current (I _{BIAS}):	3.74	mA

Calculated Results:

Approx. Turn On Time (T _{ON}):	820.1281	μs
MD Filter Capacitor (C _{MD}):	1.650	nF
Approx. APC Loop Bandwidth (f _{3dB}):	20.10	kHz

References:

1. Data Sheet: "MAX3735: 2.7Gbps, Low Power SFP Laser Driver." - Maxim Integrated Products, August 2002.
2. Application Note: "[Maintaining Average Power and Extinction Ratio, Part 1, Slope Efficiency and Threshold Current.](#)" – HFAN 02.3.1, Maxim Integrated Products, May 2002.
3. Application Note: "[Maintaining Average Power and Extinction Ratio, Part 2, MAX3893 Laser Driver and DS1847 Digital Resistor.](#)" – HFAN 02.3.2, Maxim Integrated Products, May 2002.
4. B. Sklar, Digital Communications: Fundamentals and Applications, Englewood Cliff, New Jersey: Prentice Hall pp.78-82
5. Application Note: "[NRZ Bandwidth – LF Cutoff and Baseline Wander.](#)" – HFAN 09.0.4, Maxim Integrated Products, August 2002.
6. Application Note: "[Choosing AC-Coupling Capacitors.](#)" – HFAN 01.1, Maxim Integrated Products, September 2000.
7. Application Note: "[NRZ Bandwidth – HF Cutoff vs. SNR.](#)" – HFAN 09.0.1, Maxim Integrated Products, December 2001.