

MITSUBISHI RF POWER TRANSISTOR

2SC1971

NPN EPITAXIAL PLANAR TYPE

DESCRIPTION

2SC1971 is a silicon NPN epitaxial planar type transistor designed for RF power amplifiers on VHF band mobile radio applications.

FEATURES

- High power gain: $G_{pe} \geq 10\text{dB}$
@ $V_{CC} = 13.5\text{V}$, $P_O = 6\text{W}$, $f = 175\text{MHz}$
- Emitter ballasted construction, gold metallization for high reliability and good performances.
- TO-220 package similar is convenient for mounting.
- Ability of withstanding more than 20:1 load VSWR when operated at $V_{CC} = 15.2\text{V}$, $P_O = 6\text{W}$, $f = 175\text{MHz}$.
- Equivalent input/output series impedance:
 $Z_{in} = 1.3 + j3.2 \Omega$ @ $P_O = 6\text{W}$, $V_{CC} = 13.5\text{V}$, $f = 175\text{MHz}$
 $Z_{out} = 6.2 - j3 \Omega$

APPLICATION

4 to 5 watts output power amplifiers in VHF band applications.

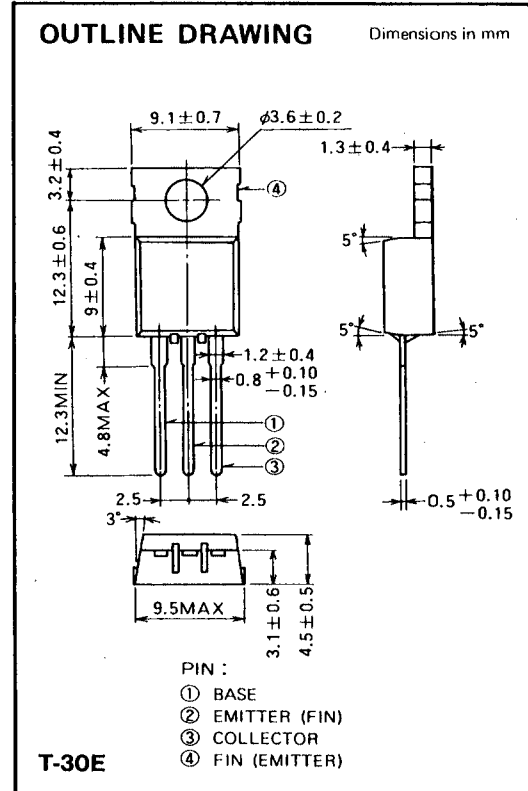

ABSOLUTE MAXIMUM RATINGS ($T_C = 25^\circ\text{C}$ unless otherwise specified)

Symbol	Parameter	Conditions	Ratings	Unit
V_{CBO}	Collector to base voltage		35	V
V_{EBO}	Emitter to base voltage		4	V
V_{CEO}	Collector to emitter voltage	$R_{BE} = \infty$	17	V
I_C	Collector current		2	A
P_C	Collector dissipation	$T_a = 25^\circ\text{C}$	1.5	W
		$T_C = 25^\circ\text{C}$	12.5	W
T_j	Junction temperature		150	$^\circ\text{C}$
T_{stg}	Storage temperature		-55 to 150	$^\circ\text{C}$
R_{th-a}	Thermal resistance	Junction to ambient	83	$^\circ\text{C/W}$
R_{th-c}		Junction to case	10	$^\circ\text{C/W}$

Note. Above parameters are guaranteed independently.

ELECTRICAL CHARACTERISTICS ($T_C = 25^\circ\text{C}$ unless otherwise specified)

Symbol	Parameter	Test conditions	Limits			Unit
			Min	Typ	Max	
$V_{(BR)EBO}$	Emitter to base breakdown voltage	$I_F = 5\text{mA}$, $I_C = 0$	4			V
$V_{(BR)CBO}$	Collector to base breakdown voltage	$I_C = 10\text{mA}$, $I_E = 0$	35			V
$V_{(BR)CEO}$	Collector to emitter breakdown voltage	$I_C = 50\text{mA}$, $R_{BE} = \infty$	17			V
I_{CBO}	Collector cutoff current	$V_{CB} = 25\text{V}$, $I_E = 0$			500	μA
I_{EBO}	Emitter cutoff current	$V_{EB} = 3\text{V}$, $I_C = 0$			500	μA
h_{FE}	DC forward current gain *	$V_{CE} = 10\text{V}$, $I_C = 0.1\text{A}$	10	50	180	—
P_O	Output power	$V_{CC} = 13.5\text{V}$, $P_{in} = 0.6\text{W}$, $f = 175\text{MHz}$	6	7		W
η_C	Collector efficiency		60	70		%

Note. * Pulse test, $P_W = 150\mu\text{s}$, duty = 5%.

Above parameters, ratings, limits and conditions are subject to change.

MITSUBISHI RF POWER TRANSISTOR
2SC1971

NPN EPITAXIAL PLANAR TYPE

TEST CIRCUIT

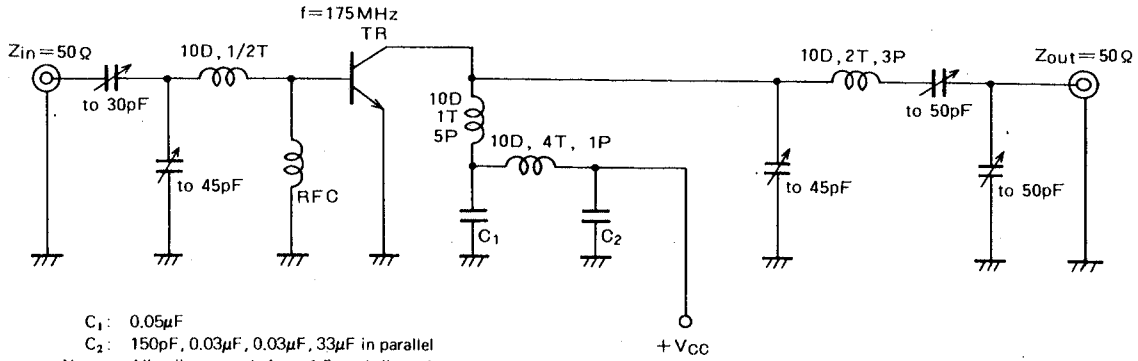

- C_1 : 0.05 μ F
 C_2 : 150pF, 0.03 μ F, 0.03 μ F, 33 μ F in parallel
 Notes: All coils are made from 1.5mm ϕ silver plated copper wire
 Coil dimensions in milli-meter
 D: Inner diameter of coil
 T: Turn number of coil
 P: Pitch of coil

TYPICAL PERFORMANCE DATA

COLLECTOR DISSIPATION VS. AMBIENT TEMPERATURE

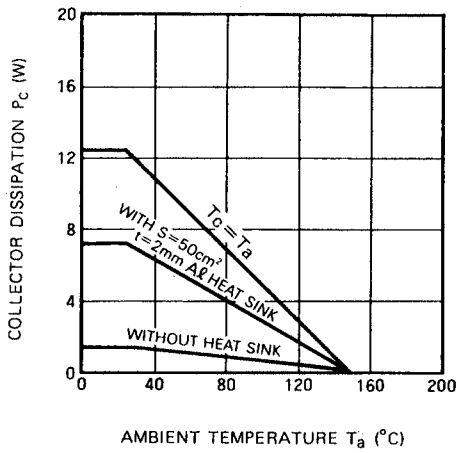

COLLECTOR CURRENT VS. COLLECTOR TO EMITTER VOLTAGE

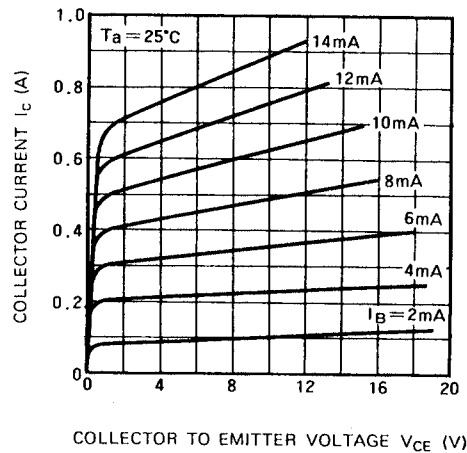

DC CURRENT GAIN VS. COLLECTOR CURRENT

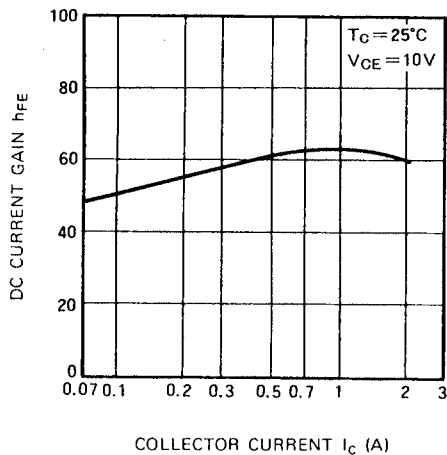

COLLECTOR TO EMITTER BREAKDOWN VOLTAGE VS. BASE TO EMITTER RESISTANCE

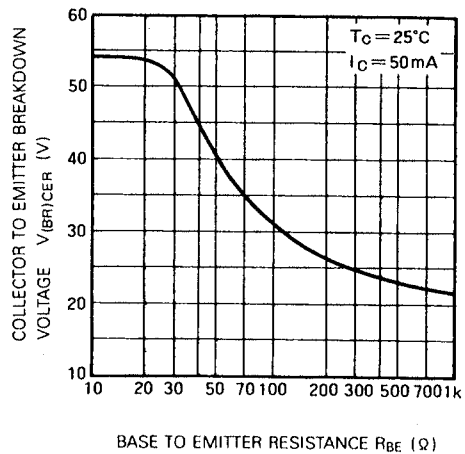

NPN EPITAXIAL PLANAR TYPE

COLLECTOR OUTPUT CAPACITANCE VS. COLLECTOR TO BASE VOLTAGE

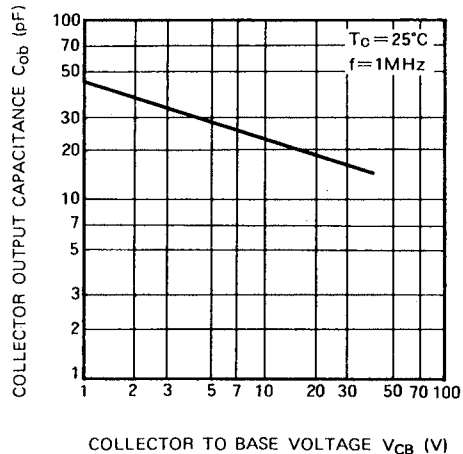

OUTPUT POWER, COLLECTOR EFFICIENCY VS. INPUT POWER

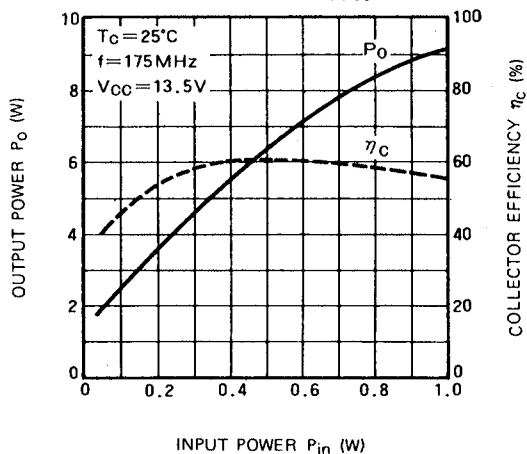

OUTPUT POWER VS. COLLECTOR SUPPLY VOLTAGE

