

SA23-11EWA/GWA/YWA/SRWA
 SC23-11EWA/GWA/YWA/SRWA
 SA23-12EWA/GWA/YWA/SRWA
 SC23-12EWA/GWA/YWA/SRWA
 SBA23-11EGWA
 SBC23-11EGWA

Features

- LARGE SIZE.
- 2.3 INCH DIGIT HEIGHT.
- LOW CURRENT OPERATION.
- EXCELLENT CHARACTER APPEARANCE.
- HIGH LIGHT OUTPUT.
- EASY MOUNTING ON P.C. BOARDS OR SOCKETS.
- MULTICOLOR AVAILABLE.
- CATEGORIZED FOR LUMINOUS INTENSITY, YELLOW AND GREEN CATEGORIZED FOR COLOR.
- MECHANICALLY RUGGED.
- STANDARD : GRAY FACE, WHITE SEGMENT.

Description

The High Efficiency Red source color devices are made with Gallium Arsenide Phosphide on Gallium Phosphide Orange Light Emitting Diode.

The Green source color devices are made with Gallium Phosphide Green Light Emitting Diode.

The Yellow source color devices are made with Gallium Arsenide Phosphide on Gallium Phosphide Yellow Light Emitting Diode.

The Super Bright Red source color devices are made with Gallium Aluminum Arsenide Red Light Emitting Diode.

Package Dimensions & Internal Circuit Diagram

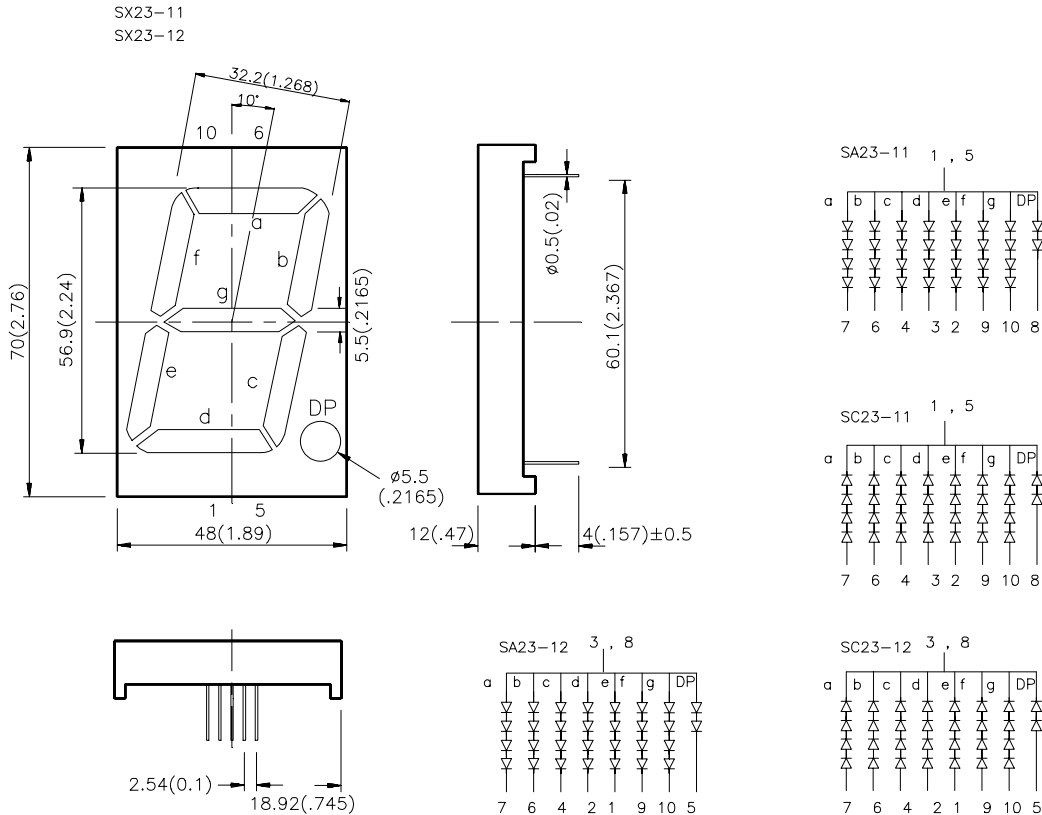

Notes:

1. All dimensions are in millimeters (inches), Tolerance is $\pm 0.25(0.01)$ unless otherwise noted.
2. Specifications are subject to change without notice.

Package Dimensions & Internal Circuit Diagram

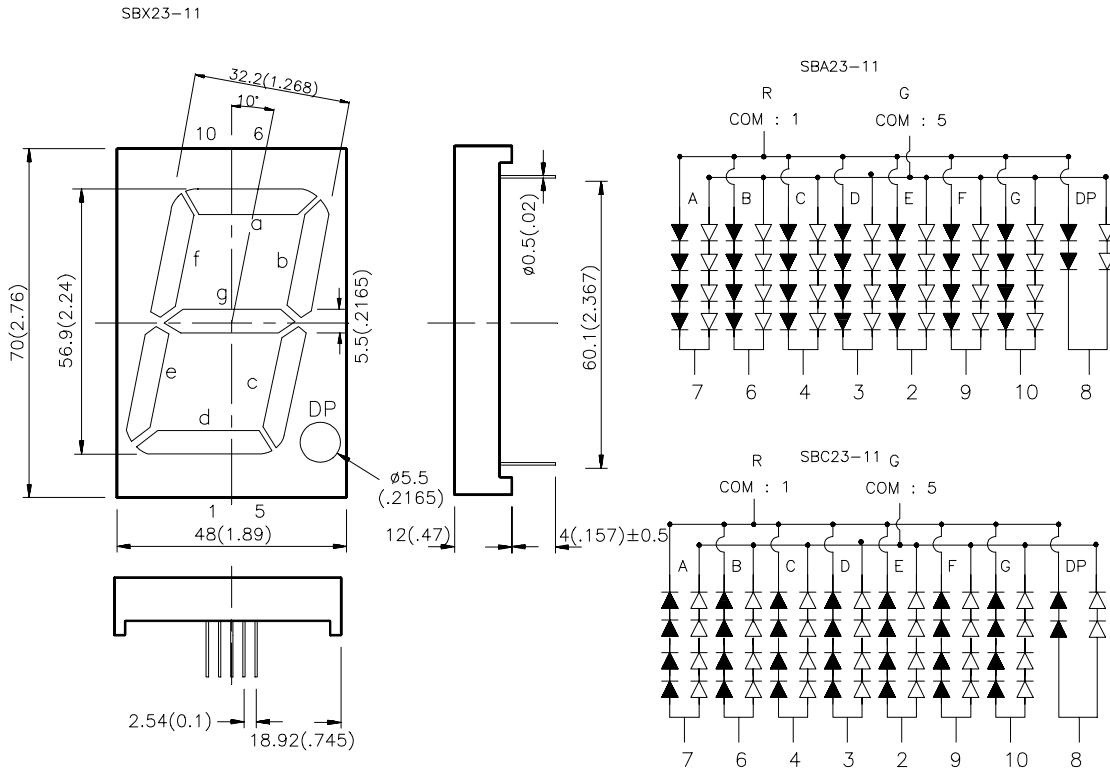

Notes:

1. All dimensions are in millimeters (inches), Tolerance is $\pm 0.25(0.01)$ unless otherwise noted.
2. Specifications are subject to change without notice.

Selection Guide

| Part No. | Dice | Iv (ucd) @ 10 mA | | Description |
|----------------------------|--|---------------------|-------|----------------------------------|
| | | Min. | Typ. | |
| SA23-11EWA SA23-12EWA | HIGH EFFICIENCY RED (GaAsP/GaP) | 8000 | 18000 | Common Anode, Rt. Hand Decimal |
| SC23-11EWA SC23-12EWA | | | | Common Cathode, Rt. Hand Decimal |
| SA23-11GWA SA23-12GWA | GREEN (GaP) | 8000 | 24000 | Common Anode, Rt. Hand Decimal |
| SC23-11GWA SC23-12GWA | | | | Common Cathode, Rt. Hand Decimal |
| SA23-11YWA SA23-12YWA | YELLOW (GaAsP/GaP) | 3000 | 8000 | Common Anode, Rt. Hand Decimal |
| SC23-11YWA SC23-12YWA | | | | Common Cathode, Rt. Hand Decimal |
| SA23-11SRWA SA23-12SRWA | SUPER BRIGHT RED (GaAlAs) | 26000 | 75000 | Common Anode, Rt. Hand Decimal |
| SC23-11SRWA SC23-12SRWA | | | | Common Cathode, Rt. Hand Decimal |
| SBA23-11EGWA | HIGH EFFICIENCY RED (GaAsP/GaP) GREEN (GaP) | 8000 | 18000 | Common Anode, Rt. Hand Decimal |
| SBC23-11EGWA | | 8000 | 24000 | Common Cathode, Rt. Hand Decimal |

Electrical / Optical Characteristics at T_A=25°C

| Symbol | Parameter | Device | Typ. | Max. | Units | Test Conditions |
|-----------------------|-------------------------|--|---------------------------|--------------------------|-------|-----------------|
| λ_{peak} | Peak Wavelength | High Efficiency Red Green Yellow Super Bright Red | 627 565 590 660 | | nm | IF=20mA |
| λ_D | Dominate Wavelength | High Efficiency Red Green Yellow Super Bright Red | 625 568 588 640 | | nm | IF=20mA |
| $\Delta\lambda_{1/2}$ | Spectral Line Halfwidth | High Efficiency Red Green Yellow Super Bright Red | 45 30 35 20 | | nm | IF=20mA |
| C | Capacitance | High Efficiency Red Green Yellow Super Bright Red | 15 15 20 45 | | pF | VF=0V;f=1MHz |
| V _F | Forward Voltage | High Efficiency Red Green Yellow Super Bright Red | 2.0 2.2 2.1 1.85 | 2.5 2.5 2.5 2.5 | V | IF=20mA |
| I _R | Reverse Current | All | | 10 | uA | VR = 5V |

Absolute Maximum Ratings at T_A=25°C

| Parameter | High Efficiency Red | Green | Yellow | Super Bright Red | Units |
|-------------------------------|---------------------|-------|--------|------------------|-------|
| Power dissipation | 105 | 105 | 105 | 100 | mW |
| DC Forward Current | 30 | 25 | 30 | 30 | mA |
| Peak Forward Current [1] | 160 | 140 | 140 | 155 | mA |
| Reverse Voltage | 5 | 5 | 5 | 5 | V |
| Operating/Storage Temperature | -40°C To +85°C | | | | |
| Lead Solder Temperature [2] | 260°C For 5 Seconds | | | | |

Notes:

- 1/10 Duty Cycle, 0.1ms Pulse Width.
- 4mm below package base.

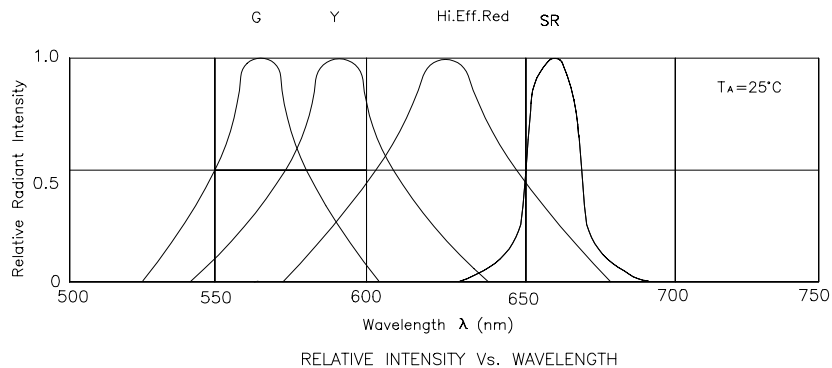

High Efficiency Red

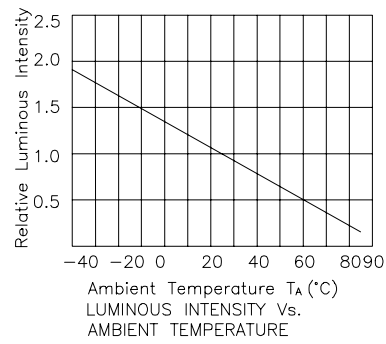
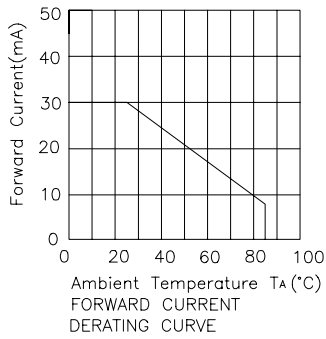
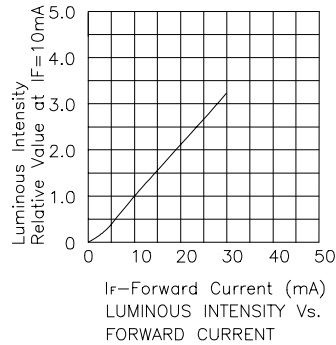
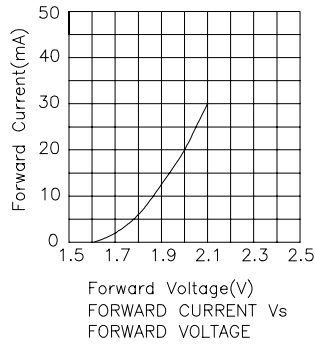

Green

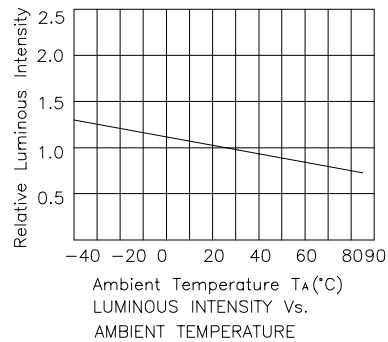
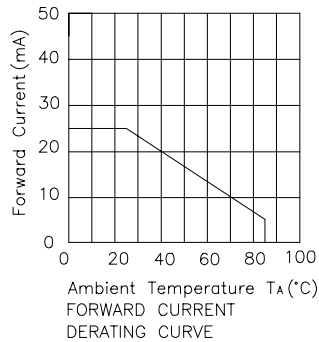
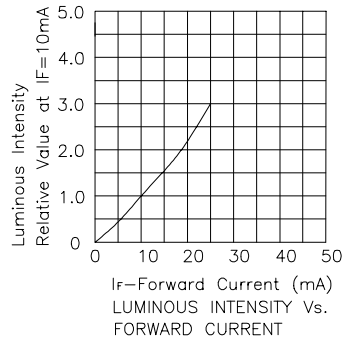
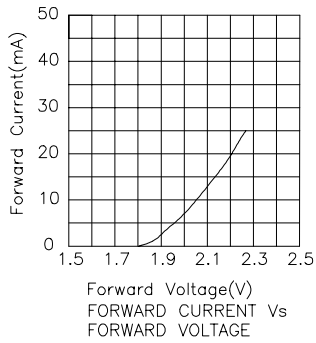

Yellow

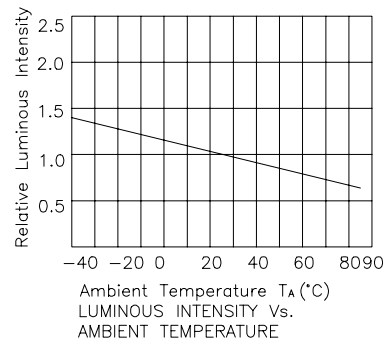
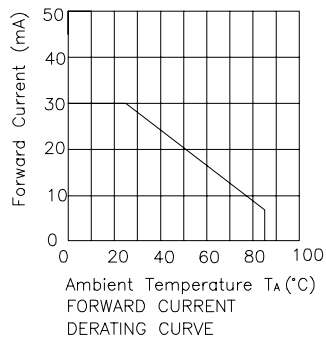
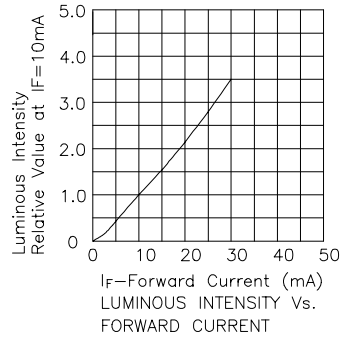
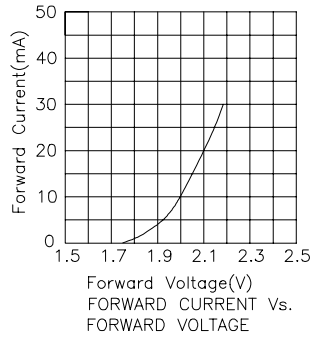

Super Bright Red

