

# ADC click

## 1. Introduction

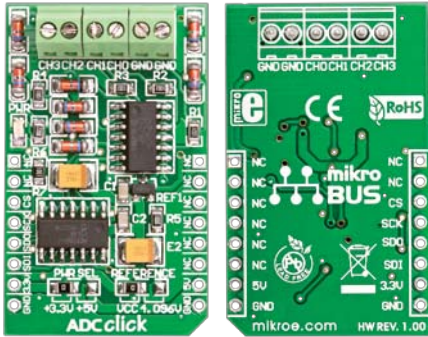

ADC Click is an accessory board in **mikroBus™** form factor. It includes a 12-bit Analog-to-Digital Converter **MCP3204** that features 50k samples/second, 4 input channels and low-power consumption (500nA typical standby, 2µA max). Board uses industry standard SPI communication interface. It is small in size and features convenient screw terminals for easier connections. Board is set to use 3.3V power supply by default. Solder **PWR SEL** SMD jumper to 5V position if used with 5V systems.

## 2. Soldering the headers

Before using your click board, make sure to solder the provided 1x8 male headers to both sides of the board. Please locate the headers in the top side of the inner box of the board package, and take them out.

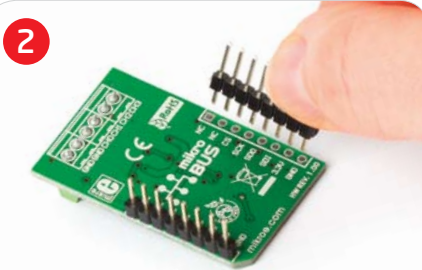
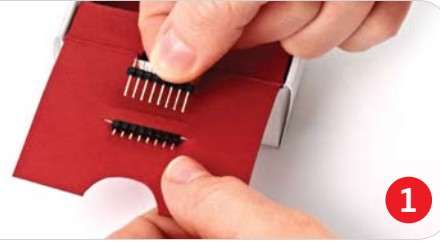

Turn the board upside down, so that bottom side is facing you upwards. Place shorter parts of the header pins in the both soldering pad locations.



Turn the board upward again. Make sure to align the headers so that they are perpendicular to the board, then solder the pins carefully.

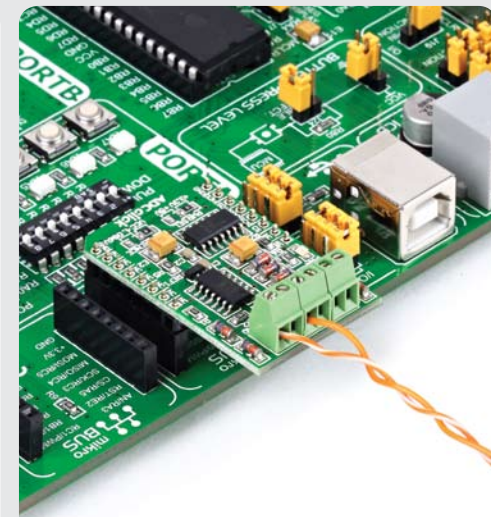

## 4. Reading Analog Inputs

There are four analog input screw terminals for each of the supported A/D channels. We added two more terminals for GND reference. Each analog input voltage is converted to appropriate 12-bit digital value, which can be read using industry standard SPI communication interface.

## 3. Plugging the board in

Once you have soldered the headers your board is ready to be placed into desired mikroBUS™ socket. Make sure to align the cut in the lower-right part of the board with the markings on the silkscreen at the mikroBUS™ socket. If all the pins are aligned correctly, push the board all the way into the socket.

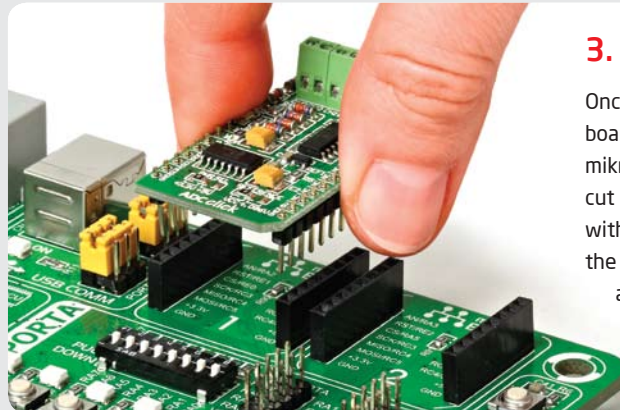

## 5. ADC click Board Schematics

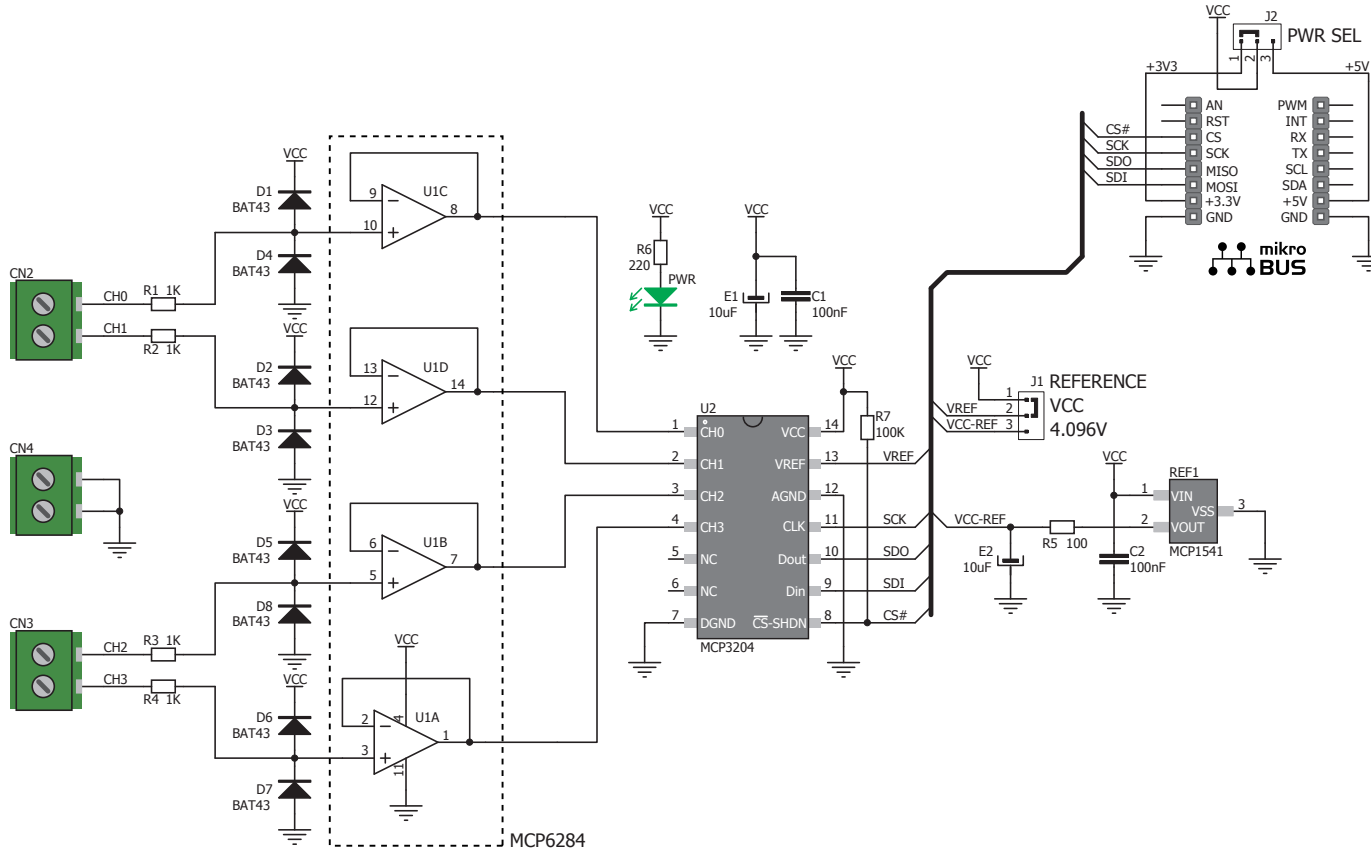

## 6. SMD Jumpers

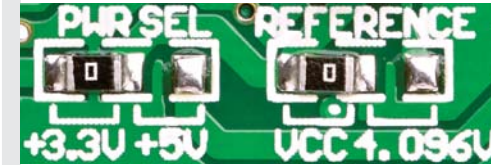

There are two zero-ohm resistors (SMD jumpers): **PWR SEL** is used to determine whether 5V or 3.3V power supply is used, and **REFERENCE** to select either VCC or 4.096V as the voltage reference.

## 7. Code Examples

Once you have done all the necessary preparations, it's time to get your click board up and running. We have provided the examples for mikroC, mikroBasic and mikroPascal compilers on our **Libstock** website. Just download them and you are ready to start.



## 8. Support

MikroElektronika offers **Free Tech Support** ([www.mikroe.com/esupport](http://www.mikroe.com/esupport)) until the end of product lifetime, so if something goes wrong, we are ready and willing to help!