

EPC2107 – Enhancement-Mode GaN Power Transistor Half Bridge With Integrated Synchronous Bootstrap Preliminary Specification Sheet

Status: Engineering

Features:

- V_{DS} , 100 V
- High Frequency Operation
- High Density Footprint
- Low Inductance Package
- Pb-Free (RoHS Compliant), Halogen Free

Applications:

- High Frequency DC-DC Conversion
- Class-D Audio
- Wireless Power (Highly Resonant and Inductive)

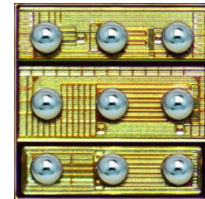
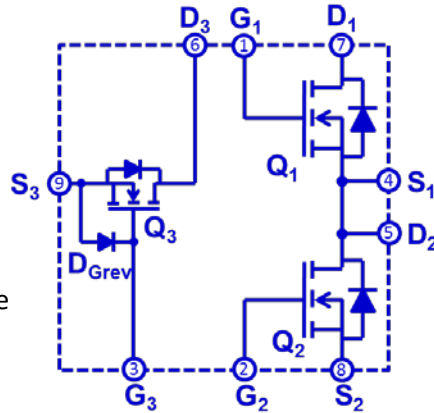

EPC2107 devices are supplied only in passivated die form with solder balls

Die Size: 1.35 mm x 1.35 mm

Typical Circuit

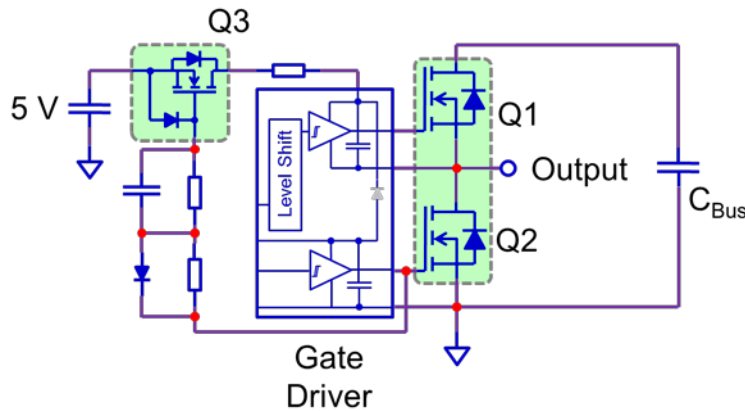

MAXIMUM RATINGS

Parameter	Device	Value
Maximum Drain – Source Voltage	Q1 & Q2	100 V
	Q3	100 V
Maximum Gate – Source Voltage Range	Q1 & Q2	-4 V < V_{GS} < 6 V
	Q3	-2 V < V_{GS} < 6 V
Continuous Drain Current, 25 °C	Q1 & Q2, $R_{\theta JA} = 74 \text{ }^\circ\text{C/W}$	1.7 A
	Q3, $R_{\theta JA} = 95 \text{ }^\circ\text{C/W}$	0.5 A
Maximum Pulsed Drain Current, 25 °C, $T_{pulse} = 300 \text{ } \mu\text{s}$	Q1 & Q2	3.8 A
	Q3	0.5 A
Operating Temperature Range	-40 °C < T_J < 150 °C	

EPC2107 – Enhancement-Mode GaN Power Transistor Half Bridge With Integrated Synchronous Bootstrap Preliminary Specification Sheet

STATIC CHARACTERISTICS

Parameter	Conditions	Q1 & Q2	Q3
Maximum Drain – Source Voltage (BV_{DSS})	$V_{GS} = 0\text{ V}$, $I_D = 0.3\text{ mA}$	100 V	100 V
Maximum Drain – Source Leakage	$V_{DS} = 80\text{ V}$, $V_{GS} = 0\text{ V}$	0.25 mA	0.1 mA
Maximum $R_{DS(on)}$	Q1/Q2: $V_{GS} = 5\text{ V}$, $I_D = 2\text{ A}$	320 m Ω	2.8 Ω
Typical $R_{DS(on)}$	Q3: $V_{GS} = 5\text{ V}$, $I_D = 0.05\text{ A}$	240 m Ω	2.1 Ω
Gate – Source Threshold Voltage	Q1/Q2: $I_D = 0.1\text{ mA}$, $V_{DS} = V_{GS}$ Q3: $I_D = 0.02\text{ mA}$, $V_{DS} = V_{GS}$	0.8 V < $V_{GS(TH)}$ < 2.5 V	
Gate – Source Maximum Positive Leakage	$V_{GS} = 5\text{ V}$	1 mA	1 mA
Gate – Source Maximum Negative Leakage	Q1/Q2: $V_{GS} = -4\text{ V}$ Q3: $V_{GS} = -1\text{ V}$	-0.25 mA	-0.1 mA
Source-Gate Maximum Forward Voltage	Q3: $I_{SG} = 0.2\text{ mA}$, $V_{DS} = 0\text{ V}$		-2 V

$T_J = 25\text{ }^\circ\text{C}$ unless otherwise stated

DYNAMIC CHARACTERISTICS

Parameter	Conditions	Typical Value			Unit
		Q1	Q2	Q3	
C_{ISS} (Input Capacitance)	$V_{DS} = 50\text{ V}$, $V_{GS} = 0\text{ V}$	16		7	pF
C_{OSS} (Output Capacitance)		10	17	1.7	
C_{RSS} (Reverse Transfer Capacitance)		0.3		0.02	
Q_G (Total Gate Charge)	Q1 & Q2: $V_{DS} = 50\text{ V}$, $V_{GS} = 5\text{ V}$, $I_D = 2\text{ A}$	160			pC
	Q3: $V_{DS} = 50\text{ V}$, $V_{GS} = 5\text{ V}$, $I_D = 0.05\text{ A}$			44	
Q_{GS} (Gate to Source Charge)	$V_{DS} = 50\text{ V}$	65		16	
Q_{GD} (Gate to Drain Charge)	Q1 & Q2: $I_D = 2\text{ A}$	40		5	
$Q_{G(TH)}$ (Gate Charge at Threshold)	Q3: $I_D = 0.05\text{ A}$	38		14	
Q_{OSS} (Output Charge)	$V_{DS} = 50\text{ V}$, $V_{GS} = 0\text{ V}$	800	1400	140	
Q_{RR} (Source-Drain Recovery Charge)		0			

$T_J = 25\text{ }^\circ\text{C}$ unless otherwise stated

EPC2107 – Enhancement-Mode GaN Power Transistor Half Bridge With Integrated Synchronous Bootstrap Preliminary Specification Sheet

THERMAL CHARACTERISTICS

		TYPICAL	
$R_{\theta JC}$	Thermal Resistance, Junction to Case	6	°C/W
$R_{\theta JB}$	Thermal Resistance, Junction to Board (Note 2)	33	°C/W
$R_{\theta JA}$	Thermal Resistance, Junction to Ambient (Note 1)	81	°C/W

Note 1: $R_{\theta JA}$ is determined with the device mounted on one square inch of copper pad, single layer 2 oz copper on FR4 board.

Thermal models for EPC devices available at <http://epc-co.com/epc/DesignSupport/DeviceModels.aspx>

EPC2107 – Enhancement-Mode GaN Power Transistor Half Bridge With Integrated Synchronous Bootstrap Preliminary Specification Sheet

Figure 1a: EPC2107-Q1&Q2: Typical Output Characteristics at 25°C

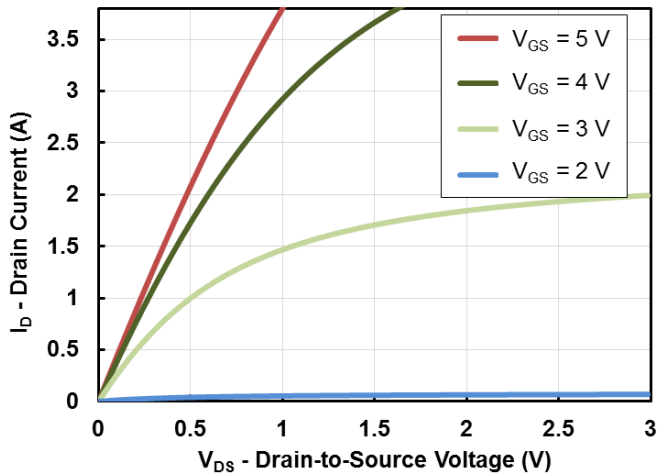

Figure 1b: EPC2107-Q3: Typical Output Characteristics at 25°C

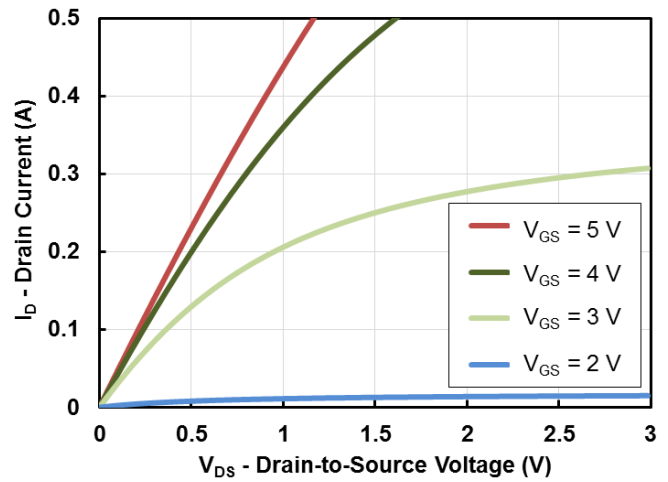

Figure 2a: EPC2107-Q1&Q2: Transfer Characteristics

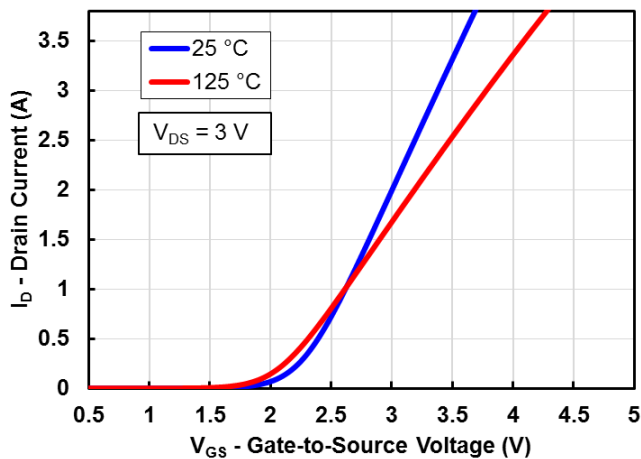

Figure 2b: EPC2107-Q3: Transfer Characteristics

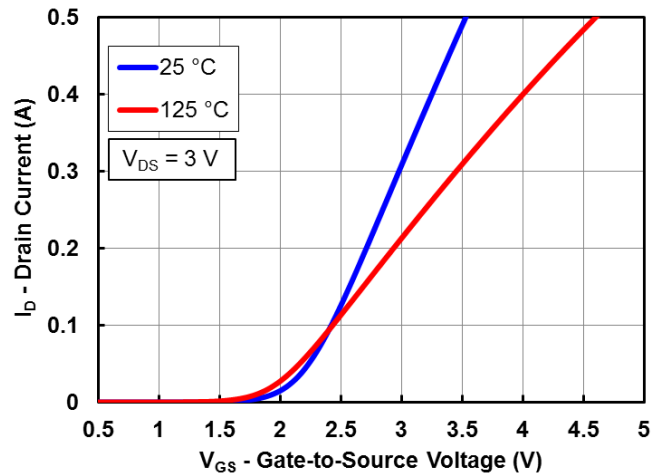

Figure 3a: EPC2107-Q1&Q2: $R_{DS(on)}$ vs. V_{GS} for Various Drain Currents

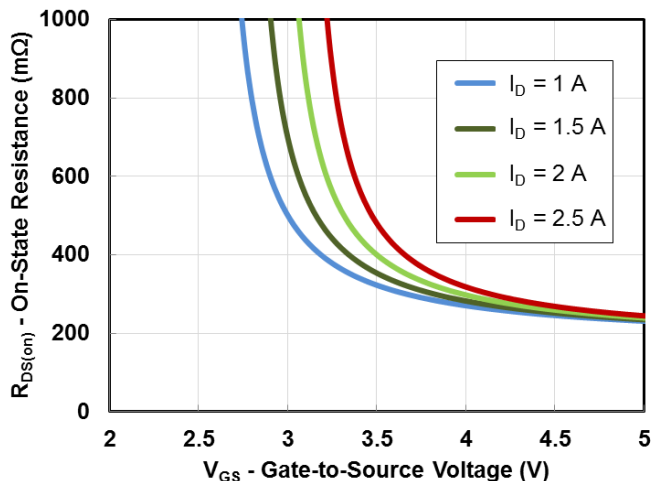
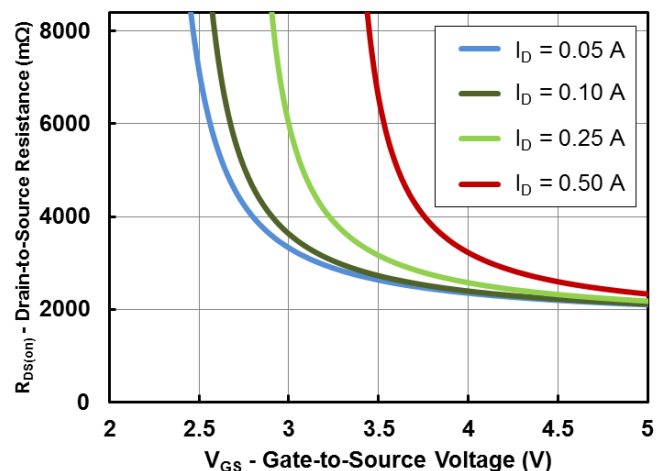

Figure 3b: EPC2107-Q3: $R_{DS(on)}$ vs. V_{GS} for Various Drain Currents



EPC2107 – Enhancement-Mode GaN Power Transistor Half Bridge With Integrated Synchronous Bootstrap Preliminary Specification Sheet

Figure 4a: EPC2107-Q1&Q2: $R_{DS(on)}$ vs. V_{GS} for Various Temperatures

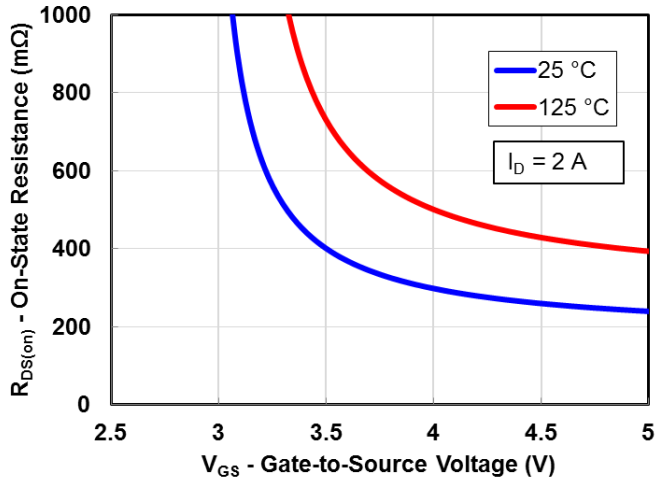

Figure 4b: EPC2107-Q3: $R_{DS(on)}$ vs. V_{GS} for Various Temperatures

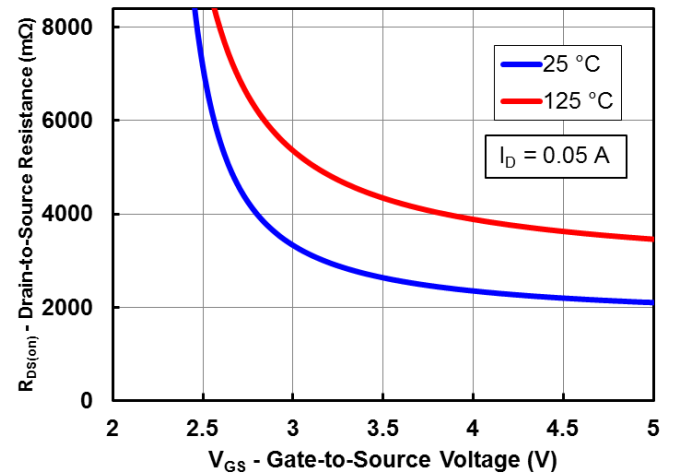

Figure 5a: EPC2107-Q1&Q2: Capacitance (Linear Scale)

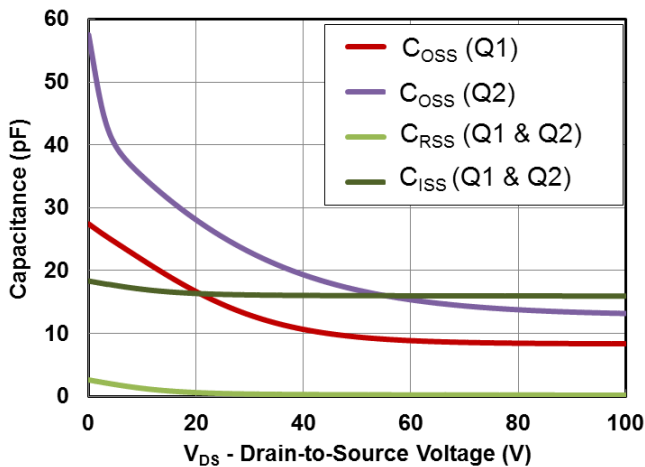

Figure 5b: EPC2107-Q3: Capacitance (Linear Scale)

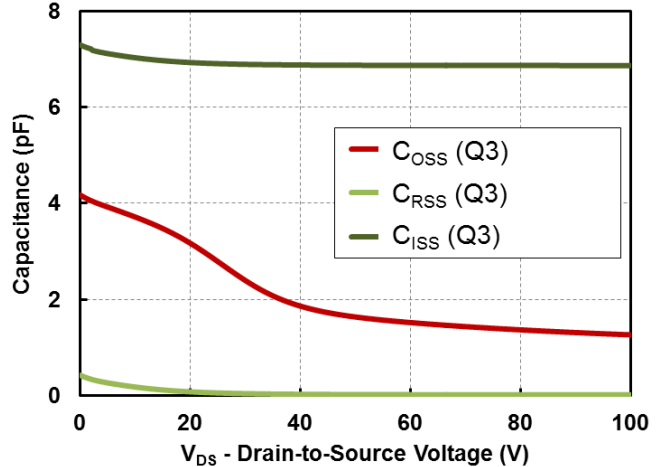

Figure 5c: EPC2107-Q1&Q2: Capacitance (Log Scale)

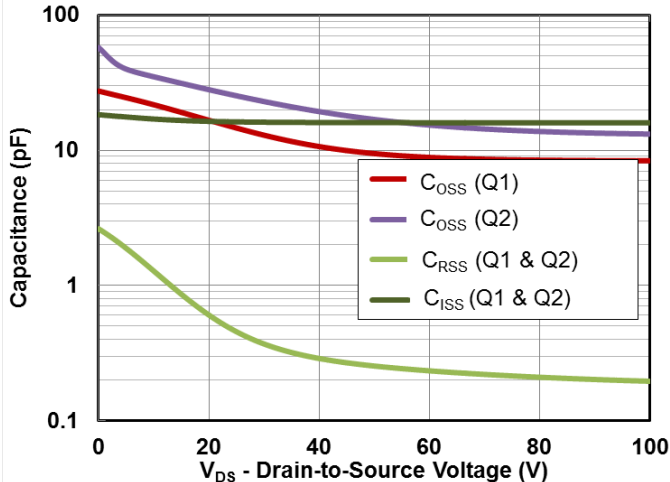
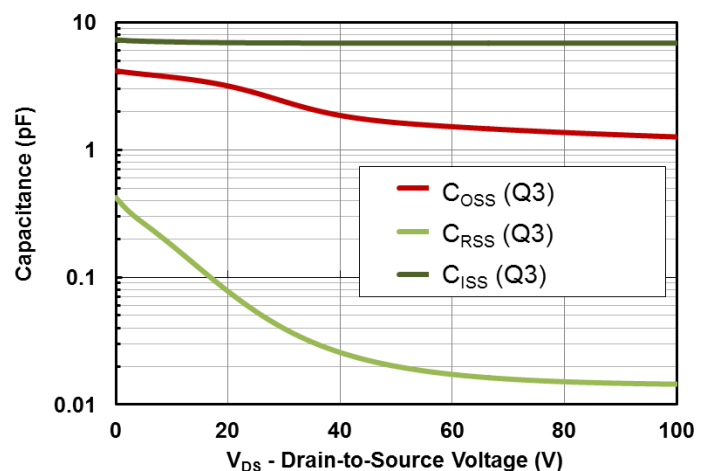

Figure 5d: EPC2107-Q3: Capacitance (Log Scale)



EPC2107 – Enhancement-Mode GaN Power Transistor Half Bridge With Integrated Synchronous Bootstrap Preliminary Specification Sheet

Figure 6a: EPC2107-Q1&Q2: Gate Charge

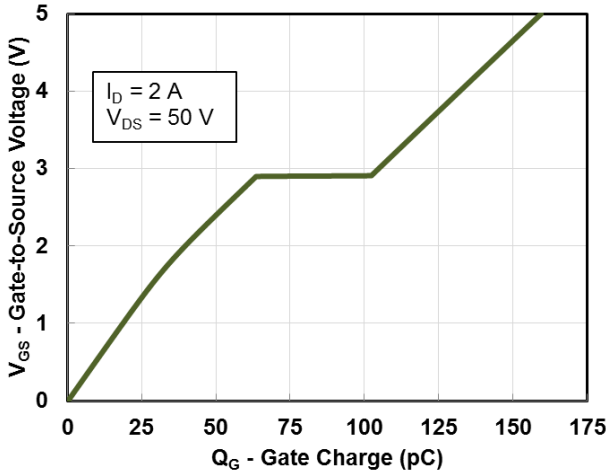

Figure 6b: EPC2107-Q3: Gate Charge

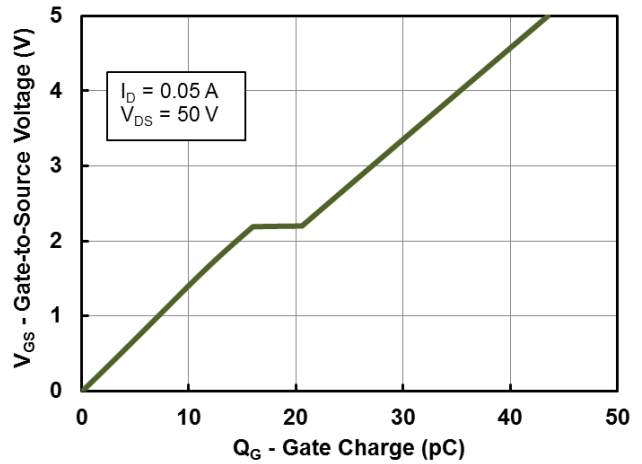

Figure 7a: EPC2107-Q1&Q2: Reverse Drain-Source Characteristics

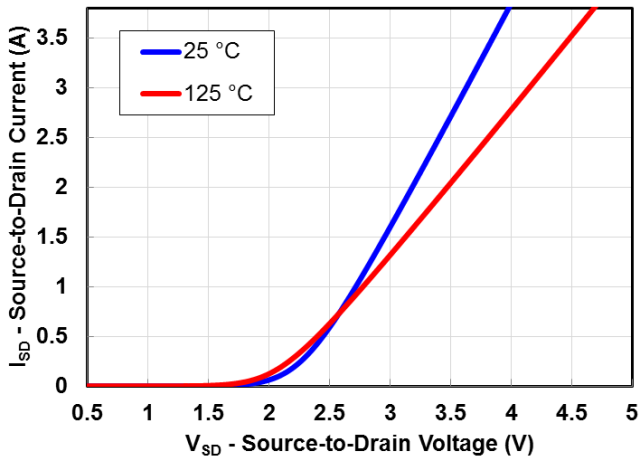

Figure 7b: EPC2107-Q3: Reverse Drain-Source Characteristics

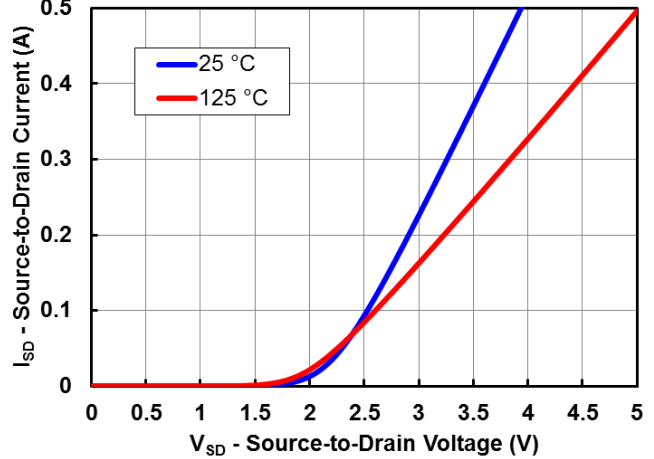

Figure 8a: EPC2107-Q1&Q2: Normalized On Resistance vs. Temperature

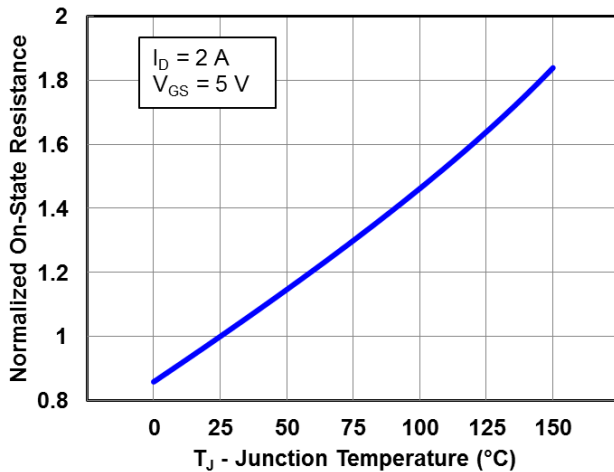
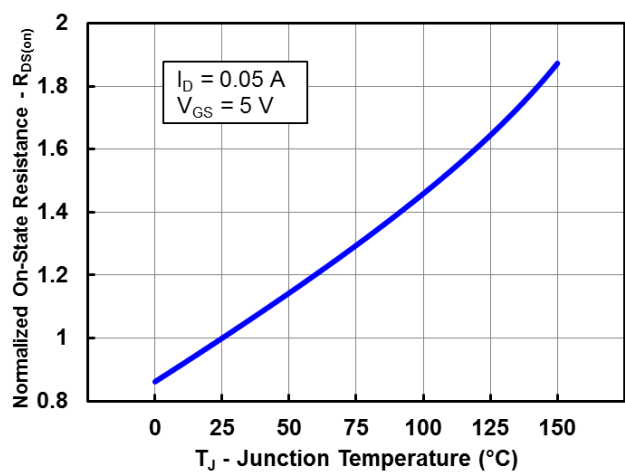

Figure 8b: EPC2107-Q3: Normalized On Resistance vs. Temperature



EPC2107 – Enhancement-Mode GaN Power Transistor Half Bridge With Integrated Synchronous Bootstrap Preliminary Specification Sheet

Figure 9a:
EPC2107-Q1&Q2: Normalized Threshold Voltage vs. Temperature

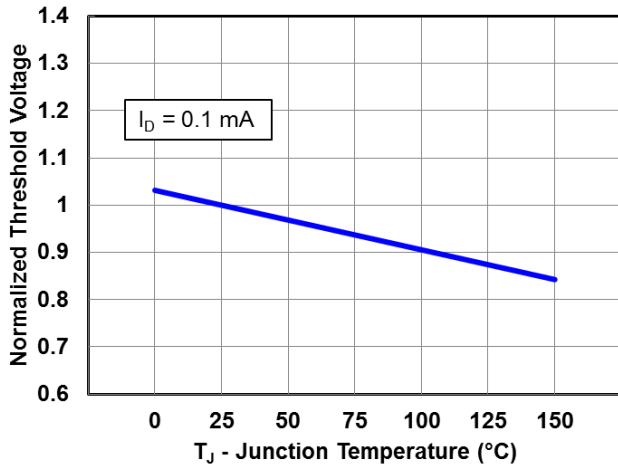
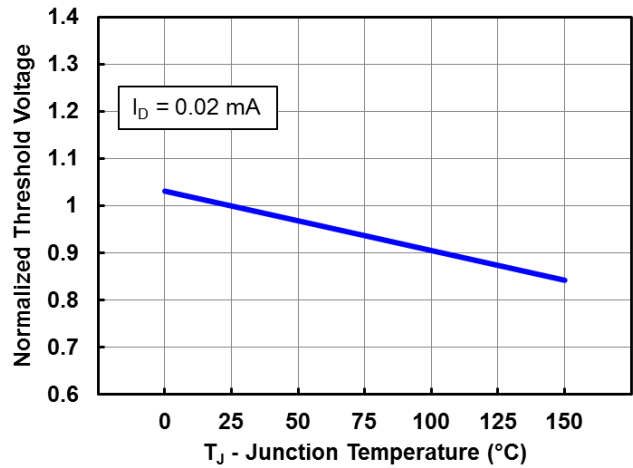
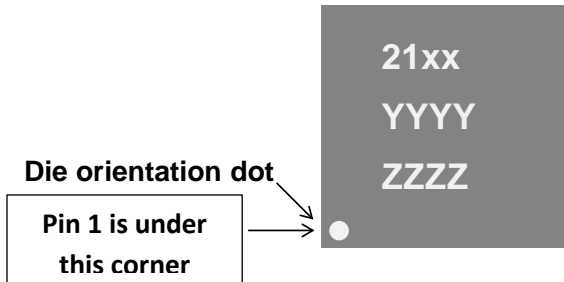

Figure 9b:
EPC2107-Q3: Normalized Threshold Voltage vs. Temperature



EPC2107 – Enhancement-Mode GaN Power Transistor Half Bridge With Integrated Synchronous Bootstrap Preliminary Specification Sheet

DIE MARKINGS



Part Number	Laser Marking		
	Part # Marking Line 1	Lot_Date Code Marking Line 2	Lot_Date Code Marking Line 3
EPC2107ENGR	21XX	YYYY	ZZZZ

DIE OUTLINE

Solder Bar View

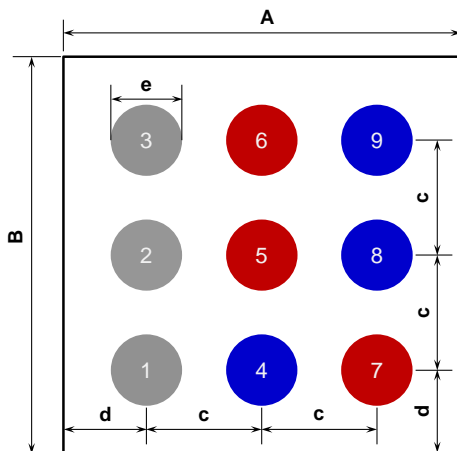

- Pad 1 is Gate1 (Q1)
- Pad 2 is Gate2 (Q2)
- Pad 3 is Gate 3 (Q3)
- Pad 7 is Drain1 (Q1)
- Pad 5 is Drain2 (Q2)
- Pad 6 is Drain3 (Q3)
- Pad 4 is Source1 (Q1)
- Pad 8 is Source2 (Q2)
- Pad 9 is Source3 (Q3)

DIM	MICROMETERS		
	MIN	Nominal	MAX
A	1320	1350	1380
B	1320	1350	1380
c	450	450	450
d	210	225	240
e	187	208	229

Side View

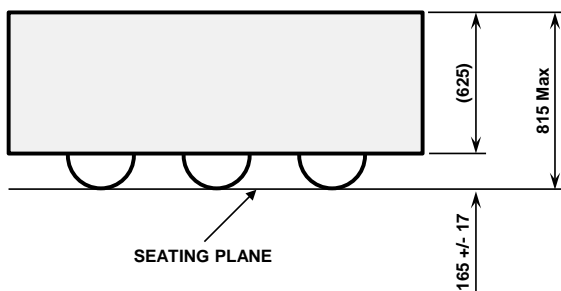

EPC2107 – Enhancement-Mode GaN Power Transistor Half Bridge With Integrated Synchronous Bootstrap Preliminary Specification Sheet

RECOMMENDED LAND PATTERN (Units in μm)

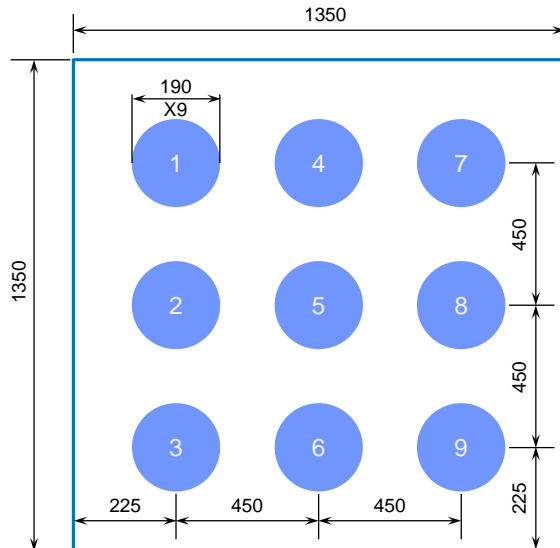

- Pad 1 is Gate1 (Q1)**
- Pad 2 is Gate2 (Q2)**
- Pad 3 is Gate3 (Q3)**
- Pad 7 is Drain1 (Q1)**
- Pad 5 is Drain2 (Q2)**
- Pad 6 is Drain3 (Q3)**
- Pad 4 is Source1 (Q1)**
- Pad 8 is Source2 (Q2)**
- Pad 9 is Source3 (Q3)**

RECOMMENDED STENCIL DESIGN (Units in μm)

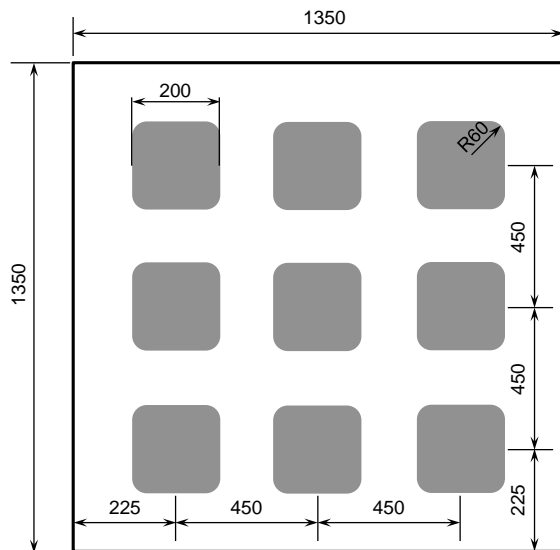

Recommended stencil should be 4mil (100 μm) thick, must be laser cut, openings per drawing.

Intended for use with SAC305 Type 4 solder, reference 88.5% metals content

Additional assembly resources available at <http://epc-co.com/epc/DesignSupport/AssemblyBasics.aspx>

Efficient Power Conversion Corporation (EPC) reserves the right to make changes without further notice to any products herein. Engineering devices, designated with an ENG* suffix at point of purchase, are first article products that EPC is preparing for production release. Specifications may change on final production release of the device. If you have questions please [contact us](#). EPC does not assume any liability arising out of the application or use of any product or circuit described herein; neither does it convey any license under its patent rights, nor the rights of other.

eGaN® is a registered trademark of Efficient Power Conversion Corporation.

U.S. Patents 8,350,294; 8,404,508; 8,431,960; 8,436,398; 8,785,974; 8,890,168; 8,969,918; 8,853,749; 8,823,012

Revised July, 2016