



COH-A2

Carbon Monoxide Hydrogen Sulfide



Technical Specification



Introduction

Personal gas safety monitors can be found in almost every industry, with the requirement for multiple gas detection becoming commonplace. Most of these gas detectors measure both Carbon Monoxide and Hydrogen Sulfide.

Alphasense new 2sense H₂S+CO gas sensor allows designers to reduce significantly their gas detector size and cost. The patented 2sense uses a new approach to dual gas sensor design.

A larger version of the D2 sensor, which has a proven track record in the field over many years, the 2sense does not compromise performance or long term stability over the standard two-sensor solution when measuring both H₂S and CO.

Specification Carbon Monoxide Channel

PERFORMANCE	Sensitivity	nA/ppm in 400ppm CO	50 to 95
	Response time	t ₉₀ (s) from zero to 400ppm CO	< 20
	Zero current	ppm equivalent in zero air	0 to -4
	Resolution	rms noise (ppm equivalent)	< 0.5
	Range	ppm CO limit of performance warranty	2,000
	Linearity	ppm error at full scale, linear at zero and 400 ppm CO	10 to 40
	Overgas limit	maximum CO for stable response to gas pulse	5,000

LIFETIME	Zero drift	ppm equivalent change/year in lab air	< 0.5
	Sensitivity drift	% change/year in lab air, monthly test	< 4
	Operating life	months until 80% original signal (24 month warranted)	24

ENVIRONMENTAL	Sensitivity @ -20°C	% (output @ -20°C/output @ 20°C) @ 100ppm CO	45 to 75
	Sensitivity @ 50°C	% (output @ 50°C/output @ 20°C) @ 100ppm CO	102 to 125
	Zero @ -20°C	ppm equivalent change from 20°C	0 to 2
	Zero @ 50°C	ppm equivalent change from 20°C	0 to -6

CROSS SENSITIVITY	Filter Capacity	ppm-hours of Hydrogen Sulfide	nd
	H ₂ S sensitivity	% measured gas @ 20ppm H ₂ S	< 5
	NO ₂ sensitivity	% measured gas @ 10ppm NO ₂	< 0.1
	Cl ₂ sensitivity	% measured gas @ 10ppm Cl ₂	< 0.1
	NO sensitivity	% measured gas @ 50ppm NO	< 50
	SO ₂ sensitivity	% measured gas @ 20ppm SO ₂	< 0.1
	H ₂ sensitivity	% measured gas @ 400ppm H ₂ @ 20°C	< 50
	C ₂ H ₄ sensitivity	% measured gas @ 400ppm C ₂ H ₄	< 100
NH ₃ sensitivity	% measured gas @ 20ppm NH ₃	< 0.1	

KEY SPECIFICATIONS	Temperature range	°C	-30 to 50
	Pressure range	kPa	80 to 120
	Humidity range	%rh continuous (see note below)	15 to 90
	Storage period	months @ 3 to 20°C (stored in sealed pot)	6
	Load resistor	Ω (recommended)	10 to 47
	Weight	g	< 6

Note: Above 85% rh and 40°C a maximum continuous exposure period of 10 days is warranted. Where such exposure occurs the sensor will recover normal electrolyte volumes, when allowed to rest at lower %rh and temperature levels for several days.



At the end of the product's life, do not dispose of any electronic sensor, component or instrument in the domestic waste, but contact the instrument manufacturer, Alphasense or its distributor for disposal instructions.

NOTE: all sensors are tested at ambient environmental conditions, with 47 ohm load resistor, unless otherwise stated. As applications of use are outside our control, the information provided is given without legal responsibility. Customers should test under their own conditions, to ensure that the sensors are suitable for their own requirements.



Performance Data Carbon Monoxide Channel

Technical Specification

Figure 1 CO Channel Sensitivity Temperature Dependence

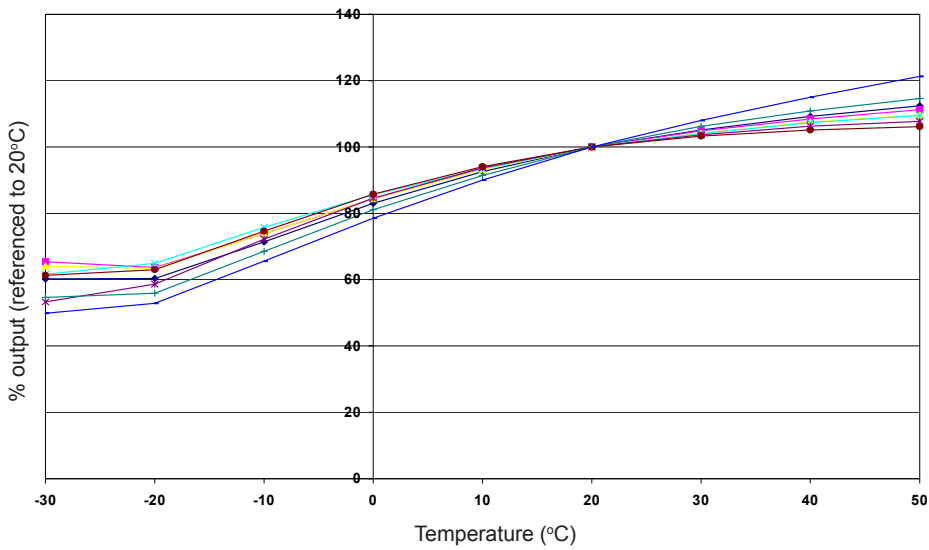

Figure 1 shows the % variation in sensitivity caused by changes in temperature.

The data is taken from a typical batch of sensors.

Figure 2 CO Channel Zero Temperature Dependence

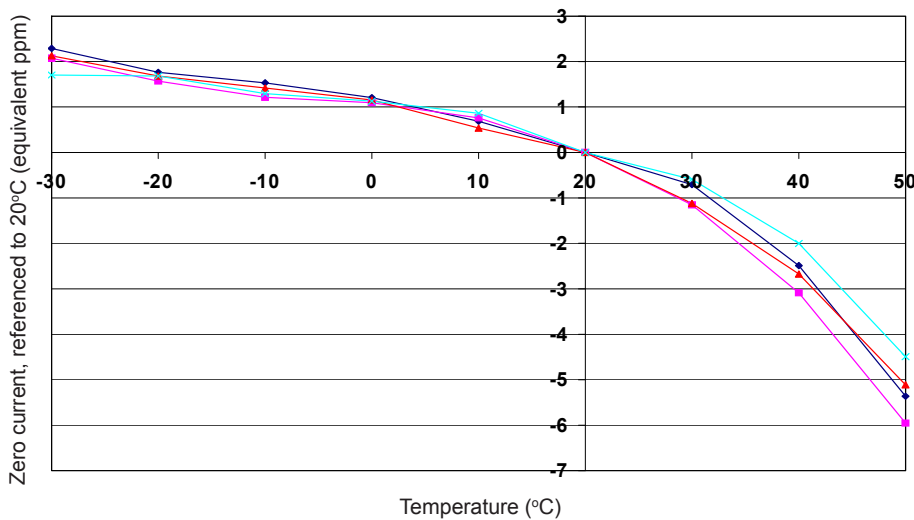

Figure 2 shows the variation in zero output caused by changes in temperature, expressed as ppm gas equivalent, referenced to the zero at 20°C.

This data is taken from a typical batch of sensors.

Figure 3 CO Channel Response to 800ppm CO

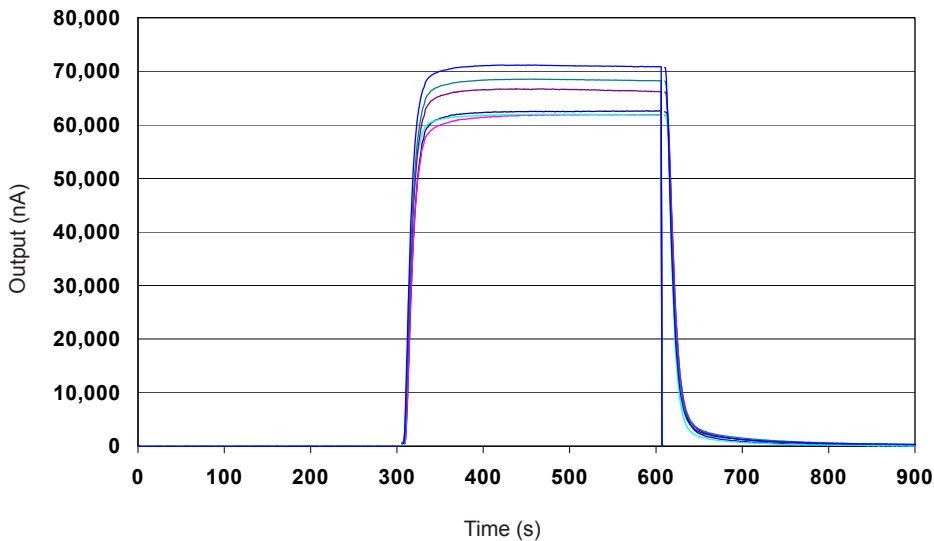

Figure 3 shows the response for a batch of sensors tested with 800ppm CO. The fast, stable response shows a robust sensor that operates well above its specification.



2
sense

COH-A2 Specification contd.



Figure 4 Schematic Diagram

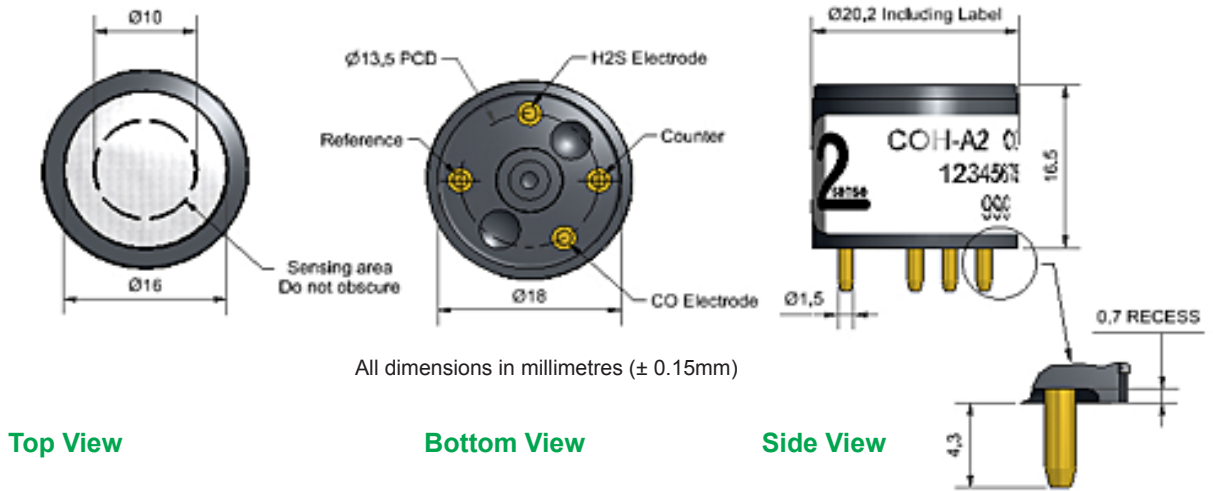

Specification Hydrogen Sulfide Channel

PERFORMANCE	Parameter	Specification	Range
	Sensitivity	nA/ppm in 20ppm H ₂ S	700 to 1000
	Response time	t ₉₀ (s) from zero to 20ppm H ₂ S @ 20°C	< 30
	Zero current	ppm equivalent in zero air	0 to -0.3
	Resolution	rms noise (ppm equivalent)	< 0.05
	Range	ppm H ₂ S limit of performance warranty	200
	Linearity	ppm error at full scale, linear at zero and 20ppm H ₂ S	0 to -3
	Overgas limit	maximum ppm H ₂ S for stable response to gas pulse	500

LIFETIME	Parameter	Specification	Range
	Zero drift	ppm equivalent change/year in lab air	< 0.1
	Sensitivity drift	% change/year in lab air, monthly test	< 2
	Operating life	months until 80% original signal (24 month warranted)	24

ENVIRONMENTAL	Parameter	Specification	Range
	Sensitivity @ -20°C	% (output @ -20°C/output @ 20°C) @ 20ppm H ₂ S	80 to 90
	Sensitivity @ 50°C	% (output @ 50°C/output @ 20°C) @ 20ppm H ₂ S	105 to 115
	Zero @ -20°C	ppm equivalent change from 20°C	< ±0.05
	Zero @ 50°C	ppm equivalent change from 20°C	< 0 to 0.2

CROSS SENSITIVITY	Gas	Parameter	Specification	Range
	NO ₂	sensitivity	% measured gas @ 10ppm NO ₂	< -25
	Cl ₂	sensitivity	% measured gas @ 10ppm Cl ₂	< -12
	NO	sensitivity	% measured gas @ 50ppm NO	< 1
	SO ₂	sensitivity	% measured gas @ 20ppm SO ₂	< 8
	CO	sensitivity	% measured gas @ 400ppm CO	< 6
	H ₂	sensitivity	% measured gas @ 400ppm H ₂	< 0.2
	C ₂ H ₄	sensitivity	% measured gas @ 400ppm C ₂ H ₄	< 0.5
NH ₃	sensitivity	% measured gas @ 20ppm NH ₃	< 0.1	

Note: Above 85% rh and 40°C a maximum continuous exposure period of 10 days is warranted. Where such exposure occurs the sensor will recover normal electrolyte volumes, when allowed to rest at lower %rh and temperature levels for several days.



Performance Data Hydrogen Sulfide Channel

Technical Specification

Figure 5 H₂S Channel Response to 25ppm H₂S

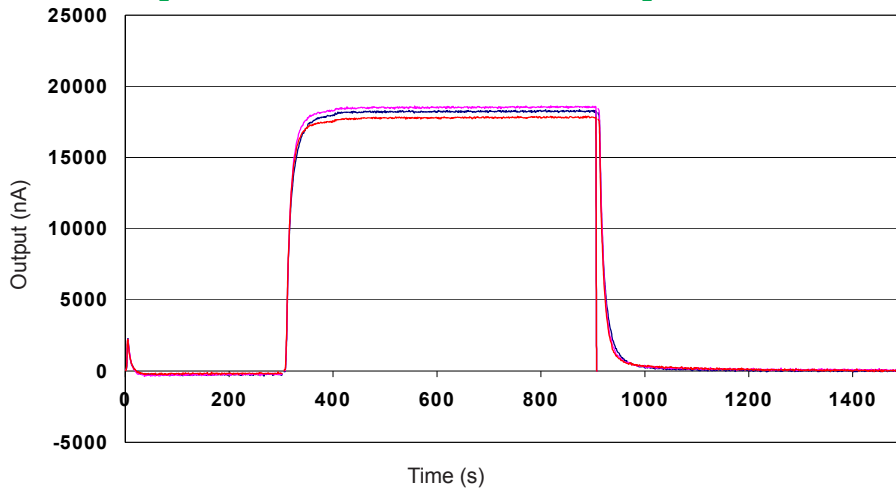

Figure 5 shows response to 25ppm H₂S. Sensor shows a fast and stable response and recovery and repeatable sensitivity.

Figure 6 H₂S Channel Sensitivity Temperature Dependence

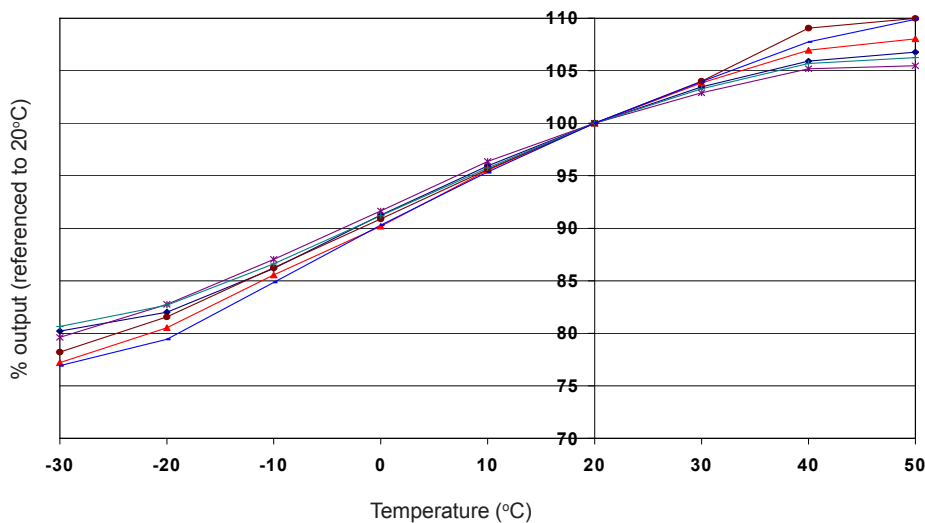

Figure 6 shows the % variation in sensitivity caused by changes in temperature.

The data is taken from a typical batch of sensors.

Figure 7 H₂S Channel Zero Temperature Dependence

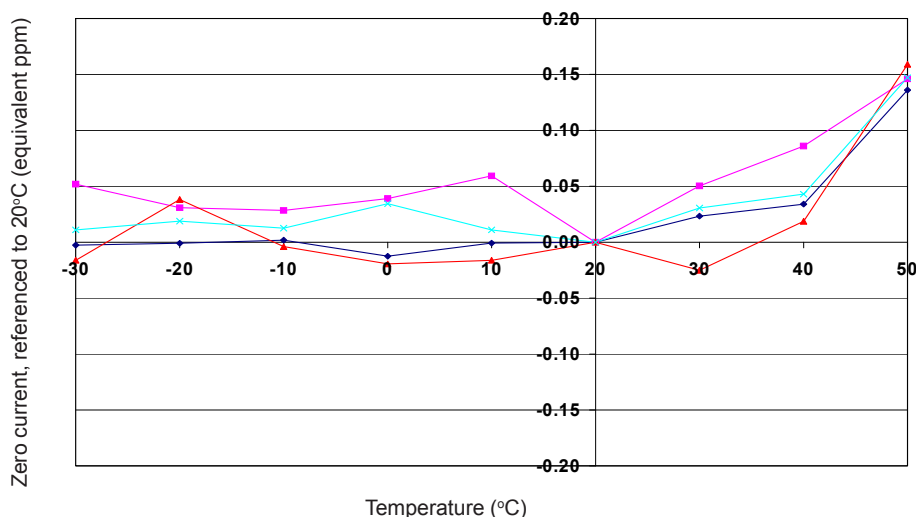

Figure 7 shows the variation in zero output caused by changes in temperature, expressed as ppm gas equivalent, referenced to the zero at 20°C.

This data is taken from a typical batch of sensors.

For further information on the performance of this sensor, on other sensors in the range or any other subject, please contact Alphasense Ltd. For Application Notes visit "www.alphasense.com".

In the interest of continued product improvement, we reserve the right to change design features and specifications without prior notification. The data contained in this document is for guidance only. Alphasense Ltd accepts no liability for any consequential losses, injury or damage resulting from the use of this document or the information contained within. (©ALPHASENSE LTD) Doc. Ref. COH-A2/NOV13