

DMOS 1A Low-Dropout Regulator

FEATURES

- **NEW DMOS TOPOLOGY:**
Ultra Low Dropout Voltage:
230mV typ at 1A and 3.3V Output
Output Capacitor NOT Required for Stability
- **FAST TRANSIENT RESPONSE**
- **VERY LOW NOISE:** 33 μ V_{RMS}
- **HIGH ACCURACY:** \pm 2% max
- **HIGH EFFICIENCY:**
 $I_{GND} = 1.7\text{mA}$ at $I_{OUT} = 1\text{A}$
Not Enabled: $I_{GND} = 0.5\mu\text{A}$
- **2.5V, 2.7V, 3.0V, 3.3V, 5.0V AND
ADJUSTABLE OUTPUT VERSIONS**
- **THERMAL PROTECTION**
- **SMALL SURFACE-MOUNT PACKAGES:**
SOT223-5, DPAK-5

APPLICATIONS

- **PORTABLE COMMUNICATION DEVICES**
- **BATTERY-POWERED EQUIPMENT**
- **MODEMS**
- **BAR-CODE SCANNERS**
- **BACKUP POWER SUPPLIES**

DESCRIPTION

The REG104 is a family of low-noise, low-dropout linear regulators with low ground pin current. Its new DMOS topology provides significant improvement over previous designs, including low dropout voltage (only 230mV typ at full load), and better transient performance. In addition, no output capacitor is required for stability, unlike conventional low dropout regulators that are difficult to compensate and require expensive low ESR capacitors greater than 1 μ F.

Typical ground pin current is only 1.7mA (at $I_{OUT} = 1\text{A}$) and drops to 0.5 μ A in *not enabled* mode. Unlike regulators with PNP pass devices, quiescent current remains relatively constant over load variations and under dropout conditions.

The REG104 has very low output noise (typically 33 μ V_{RMS} for $V_{OUT} = 3.3\text{V}$ with $C_{NR} = 0.01\mu\text{F}$), making it ideal for use in portable communications equipment. On-chip trimming results in high output voltage accuracy. Accuracy is maintained over temperature, line, and load variations. Key parameters are tested over the specified temperature range (–40°C to +85°C).

The REG104 is well protected—internal circuitry provides a current limit which protects the load from damage. Thermal protection circuitry keeps the chip from being damaged by excessive temperature. The REG104 is available in the DPAK-5 and the SOT223-5.

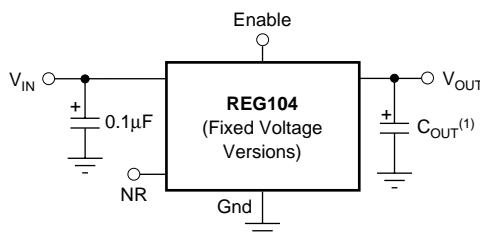

NR = Noise Reduction

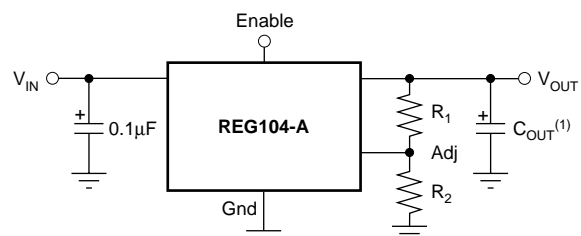

NOTE: (1) Optional.



Please be aware that an important notice concerning availability, standard warranty, and use in critical applications of Texas Instruments semiconductor products and disclaimers thereto appears at the end of this data sheet.

All trademarks are the property of their respective owners.

ABSOLUTE MAXIMUM RATINGS⁽¹⁾

Supply Input Voltage, V_{IN}	-0.3V to 16V
Enable Input	-0.3V to V_{IN}
Output Short-Circuit Duration	Indefinite
Operating Temperature Range	-55°C to +125°C
Storage Temperature Range	-65°C to +150°C
Junction Temperature	-55°C to +150°C
Lead Temperature (soldering, 3s, SOT, and DDPAK)	+240°C

NOTE: (1) Stresses above these ratings may cause permanent damage. Exposure to absolute maximum conditions for extended periods may degrade device reliability.



ELECTROSTATIC DISCHARGE SENSITIVITY

This integrated circuit can be damaged by ESD. Texas Instruments recommends that all integrated circuits be handled with appropriate precautions. Failure to observe proper handling and installation procedures can cause damage.

ESD damage can range from subtle performance degradation to complete device failure. Precision integrated circuits may be more susceptible to damage because very small parametric changes could cause the device not to meet its published specifications.

PACKAGE/ORDERING INFORMATION⁽¹⁾

PRODUCT	PACKAGE-LEAD	PACKAGE DESIGNATOR	SPECIFIED TEMPERATURE RANGE	PACKAGE MARKING	ORDERING NUMBER	TRANSPORT MEDIA, QUANTITY
5V Output REG104FA-5 " " REG104GA-5 " "	DDPAK-5 " " SOT223-5 " "	KTT " " DCQ " "	-40°C to +85°C " " -40°C to +85°C " "	REG104FA-5.0 " " R104G50 " "	REG104FA-5/KTTT REG104FA-5/500 REG104GA-5 REG104GA-5	Tape and Reel, 50 Tape and Reel, 500 Rails, 78 Tape and Reel, 2500
3.3V Output REG104FA-3.3 " " REG104GA-3.3 " "	DDPAK-5 " " SOT223-5 " "	KTT " " DCQ " "	-40°C to +85°C " " -40°C to +85°C " "	REG104FA-3.3 " " R104G33 " "	REG104FA-3.3/KTTT REG104FA-3.3/500 REG104GA-3.3 REG104GA-3.3	Tape and Reel, 50 Tape and Reel, 500 Rails, 78 Tape and Reel, 2500
3.0V Output REG104FA-3 " " REG104GA-3 " "	DDPAK-5 " " SOT223-5 " "	KTT " " DCQ " "	-40°C to +85°C " " -40°C to +85°C " "	REG104FA-3.0 " " R104G30 " "	REG104FA-3/KTTT REG104FA-3/500 REG104GA-3 REG104GA-3	Tape and Reel, 50 Tape and Reel, 500 Rails, 78 Tape and Reel, 2500
2.7V Output REG104FA-2.7 " " REG104GA-2.7 " "	DDPAK-5 " " SOT223-5 " "	KTT " " DCQ " "	-40°C to +85°C " " -40°C to +85°C " "	REG104FA-2.7 " " R104G27 " "	REG104FA-2.7/KTTT REG104FA-2.7/500 REG104GA-2.7 REG104GA-2.7	Tape and Reel, 50 Tape and Reel, 500 Rails, 78 Tape and Reel, 2500
2.5V Output REG104FA-2.5 " " REG104GA-2.5 " "	DDPAK-5 " " SOT223-5 " "	KTT " " DCQ " "	-40°C to +85°C " " -40°C to +85°C " "	REG104FA-2.5 " " R104G25 " "	REG104FA-2.5/KTTT REG104FA-2.5/500 REG104GA-2.5 REG104GA-2.5	Tape and Reel, 50 Tape and Reel, 500 Rails, 78 Tape and Reel, 2500
Adjustable Output REG104FA-A " " REG104GA-A " "	DDPAK-5 " " SOT223-5 " "	KTT " " DCQ " "	-40°C to +85°C " " -40°C to +85°C " "	REG104FA-A " " R104GA " "	REG104FA-A/KTTT REG104FA-A/500 REG104GA-A REG104GA-A	Tape and Reel, 50 Tape and Reel, 500 Rails, 78 Tape and Reel, 2500

NOTE: (1) For the most current package and ordering information, refer to our web site at www.ti.com.

PIN CONFIGURATIONS

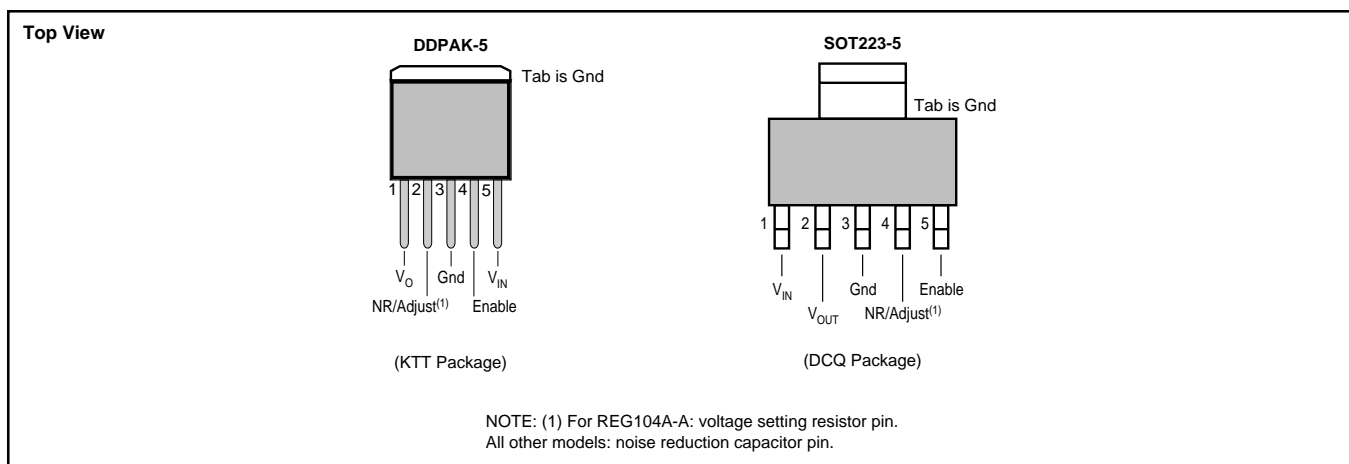

ELECTRICAL CHARACTERISTICS: $V_S = +2.7V$ to $+5.5V$

Boldface limits apply over the specified temperature range, $T_J = -40^\circ\text{C}$ to $+85^\circ\text{C}$

At $T_J = +25^\circ\text{C}$, $V_{IN} = V_{OUT} + 1V$ ($V_{OUT} = 3.0V$ for REG104-A), $V_{ENABLE} = 2V$, $I_{OUT} = 10\text{mA}$, $C_{NR} = 0.01\mu\text{F}$, and $C_{OUT} = 0.1\mu\text{F}$ ⁽¹⁾, unless otherwise noted.

PARAMETER	CONDITION	REG104GA REG104FA			UNITS
		MIN	TYP	MAX	
OUTPUT VOLTAGE					
Output Voltage Range	V_{OUT}				V
REG104-2.5			2.5		V
REG104-2.7			2.7		V
REG104-3.0			3.0		V
REG104-3.3			3.3		V
REG104-5			5		V
REG104-A		V_{REF}		5.5	V
Reference Voltage	V_{REF}		1.295		V
Adjust Pin Current	I_{ADJ}		0.2	1	μA
Accuracy			± 0.5	± 2	%
$T_J = -40^\circ\text{C}$ to $+85^\circ\text{C}$ vs Temperature	dV_{OUT}/dT	$T_J = -40^\circ\text{C}$ to $+85^\circ\text{C}$ $I_{OUT} = 10\text{mA}$ to 1A , $V_{IN} = (V_{OUT} + 0.7V)$ to $15V$ $V_{IN} = (V_{OUT} + 0.9V)$ to $15V$	70	± 3.0	ppm/ $^\circ\text{C}$
vs Line and Load			± 0.5	± 2.5	%
$T_J = -40^\circ\text{C}$ to $+85^\circ\text{C}$				± 3.5	%
DC DROPOUT VOLTAGE ^(2, 3)	V_{DROP}				mV
For all models except 5V		$I_{OUT} = 10\text{mA}$	3	25	mV
For all models except 5V		$I_{OUT} = 1\text{A}$	230	400	mV
For 5V model		$I_{OUT} = 1\text{A}$	320	500	mV
For all models except 5V		$I_{OUT} = 1\text{A}$		480	mV
$T_J = -40^\circ\text{C}$ to $+85^\circ\text{C}$					
For 5V models		$I_{OUT} = 1\text{A}$		580	mV
$T_J = -40^\circ\text{C}$ to $+85^\circ\text{C}$					
VOLTAGE NOISE	V_n				μV_{RMS}
$f = 10\text{Hz}$ to 100kHz		$C_{NR} = 0$, $C_{OUT} = 0$	$35\mu\text{V}_{RMS}/V \cdot V_{OUT}$		μV_{RMS}
Without C_{NR} (all models)		$C_{NR} = 0.01\mu\text{F}$, $C_{OUT} = 10\mu\text{F}$	$10\mu\text{V}_{RMS}/V \cdot V_{OUT}$		μV_{RMS}
With C_{NR} (all fixed voltage models)					
OUTPUT CURRENT	I_{CL}				A
Current Limit ⁽⁴⁾			1.2	1.7	A
$T_J = -40^\circ\text{C}$ to $+85^\circ\text{C}$			1.0	2.2	A
RIPPLE REJECTION					dB
$f = 120\text{Hz}$				65	
ENABLE CONTROL	V_{ENABLE}				V
V_{ENABLE} High (output enabled)		$V_{ENABLE} = 2V$ to V_{IN} ; $V_{IN} = 2.1V$ to 6.5 ⁽⁵⁾	2	V_{IN}	V
V_{ENABLE} Low (output disabled)		$V_{ENABLE} = 0V$ to $0.5V$	-0.2	0.5	V
I_{ENABLE} High (output enabled)	I_{ENABLE}		1	100	nA
I_{ENABLE} Low (output disabled)			2	100	nA
Output Disable Time			50		μs
Output Enable Softstart Time			1.5		ms
THERMAL SHUTDOWN					$^\circ\text{C}$
Junction Temperature			150		$^\circ\text{C}$
Shutdown			130		$^\circ\text{C}$
Reset from Shutdown					
GROUND PIN CURRENT	I_{GND}				mA
Ground Pin Current		$I_{OUT} = 10\text{mA}$	0.5	0.7	mA
		$I_{OUT} = 1\text{A}$	1.7	1.8	mA
Enable Pin Low		$V_{ENABLE} \leq 0.5V$	0.5		μA
INPUT VOLTAGE	V_{IN}				V
Operating Input Voltage Range ⁽⁶⁾			2.1	15	V
Specified Input Voltage Range		$V_{IN} > 2.7V$	$V_{OUT} + 0.7$	15	V
$T_J = -40^\circ\text{C}$ to $+85^\circ\text{C}$		$V_{IN} > 2.9V$	$V_{OUT} + 0.9$	15	V
TEMPERATURE RANGE	T_J				$^\circ\text{C}$
Specified Range			-40	+85	$^\circ\text{C}$
Operating Range			-55	+125	$^\circ\text{C}$
Storage Range			-65	+150	$^\circ\text{C}$
Thermal Resistance					$^\circ\text{C}/W$
DDPAK-5 Surface Mount	θ_{JC}	Junction-to-Case	4		$^\circ\text{C}/W$
SOT223-5 Surface Mount	θ_{JC}	Junction-to-Case	15		$^\circ\text{C}/W$

- NOTES: (1) The REG104 does not require a minimum output capacitor for stability. However, transient response can be improved with proper capacitor selection.
(2) Dropout voltage is defined as the input voltage minus the output voltage that produces a 2% change in the output voltage from the value at $V_{IN} = V_{OUT} + 1V$ at fixed load.
(3) Not applicable for V_{OUT} less than 2.7V.
(4) Current limit is the output current that produces a 15% change in output voltage from $V_{IN} = V_{OUT} + 1V$ and $I_{OUT} = 10\text{mA}$.
(5) For $V_{IN} > 6.5V$, see typical characteristic V_{ENABLE} vs I_{ENABLE} .
(6) The REG104 no longer regulates when $V_{IN} < V_{OUT} + V_{DROP(MAX)}$. In drop-out or when the input voltage is between 2.7V and 2.1V, the impedance from V_{IN} to V_{OUT} is typically less than 1Ω at $T_J = +25^\circ\text{C}$. See typical characteristic *Output Voltage Change vs V_{IN}* .

TYPICAL CHARACTERISTICS

For all models, at $T_J = +25^\circ\text{C}$ and $V_{\text{ENABLE}} = 2\text{V}$, unless otherwise noted.

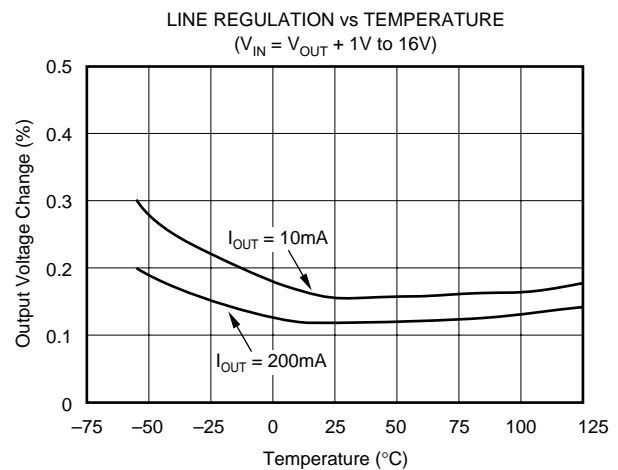
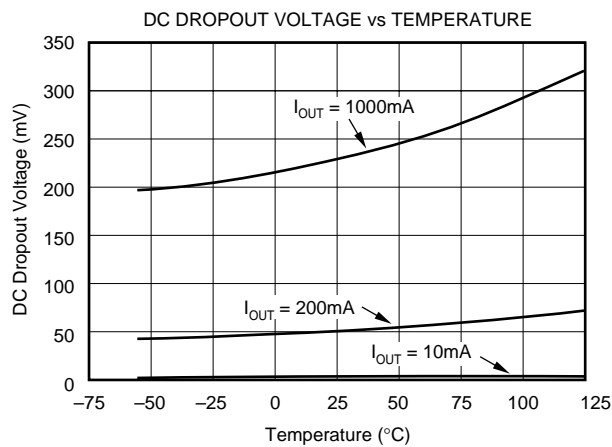
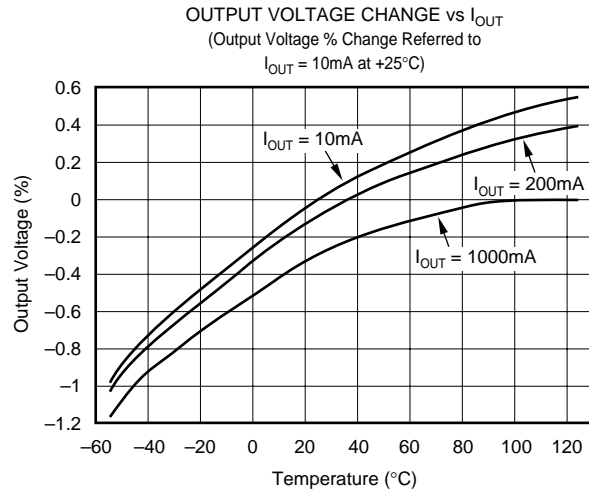
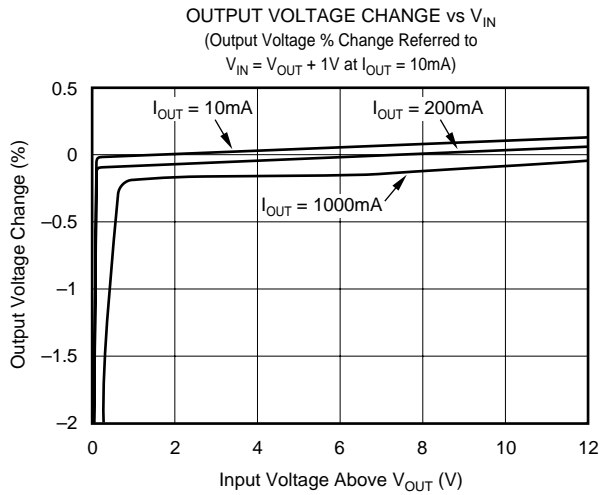
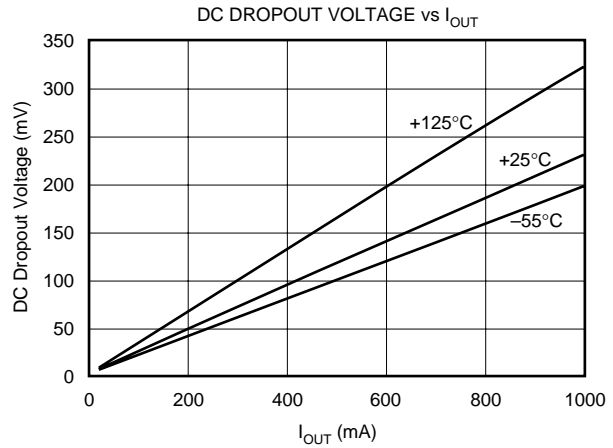
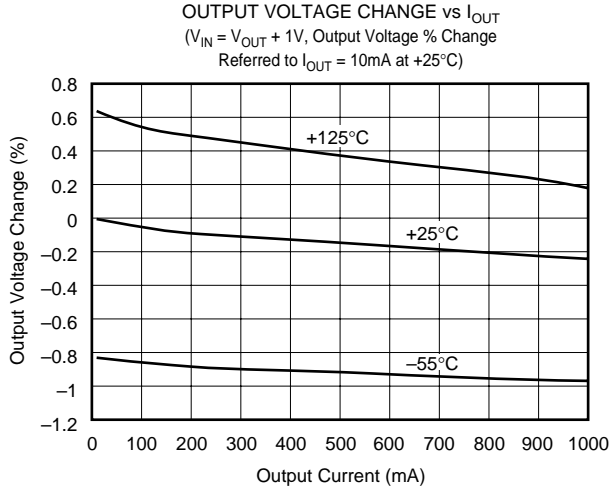

TYPICAL CHARACTERISTICS (Cont.)

For all models, at $T_J = +25^\circ\text{C}$ and $V_{\text{ENABLE}} = 2\text{V}$, unless otherwise noted.

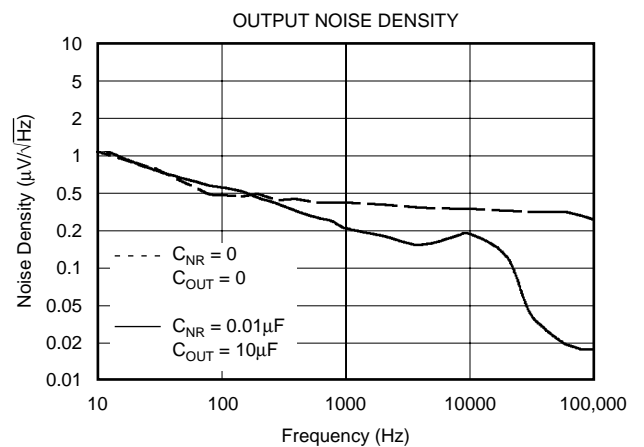
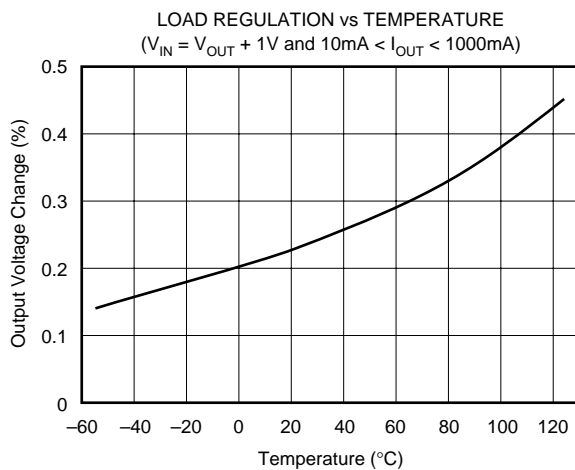
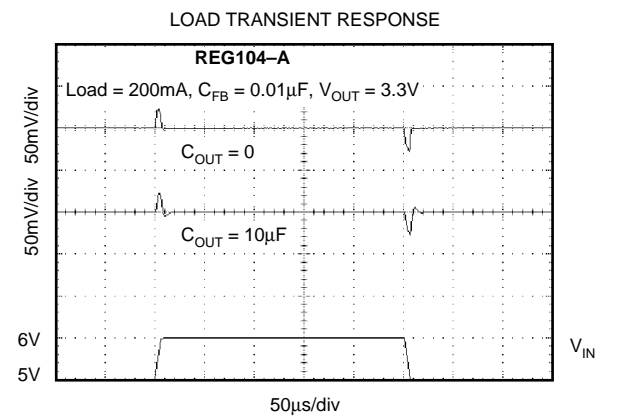
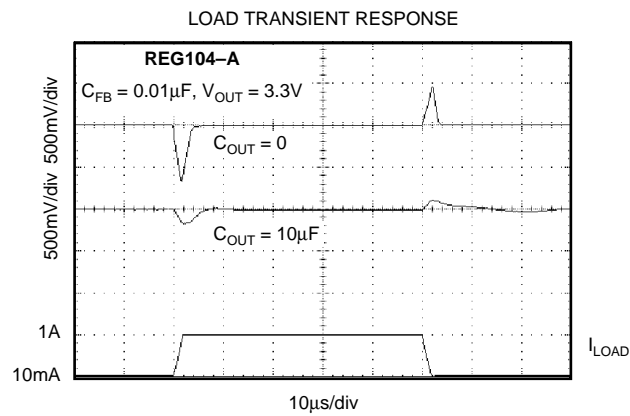
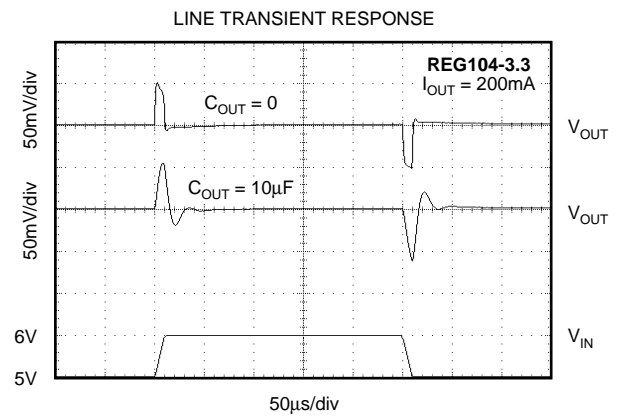
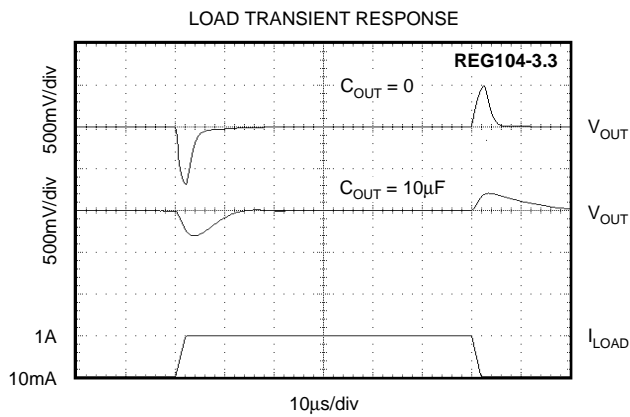

TYPICAL CHARACTERISTICS (Cont.)

For all models, at $T_J = +25^\circ\text{C}$ and $V_{\text{ENABLE}} = 2\text{V}$, unless otherwise noted.

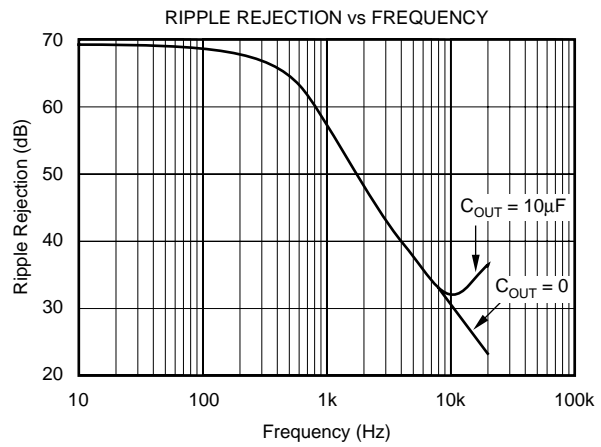
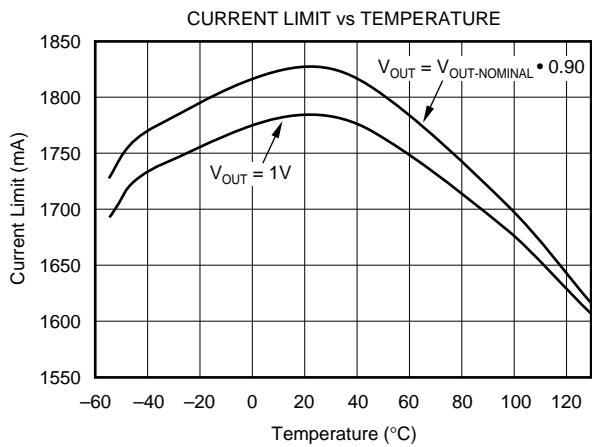
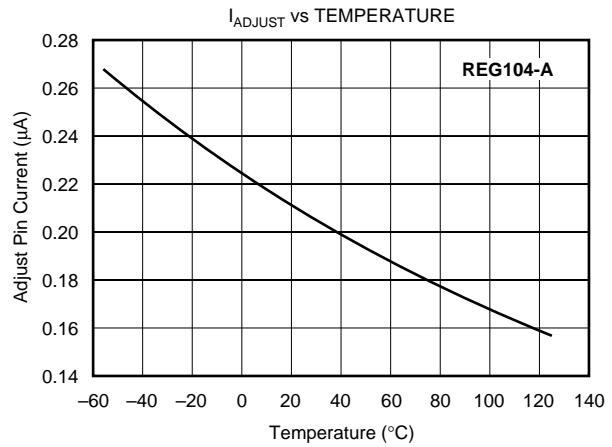
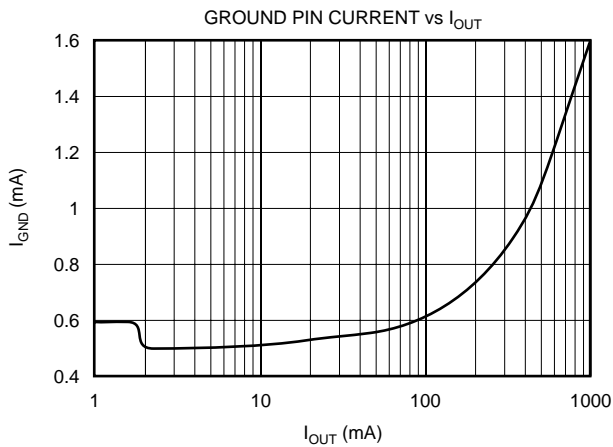
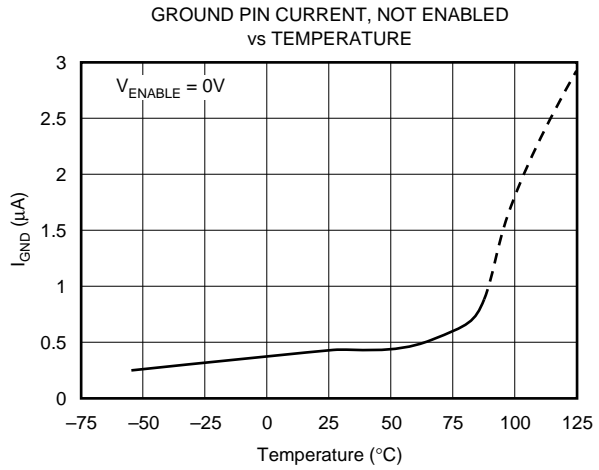
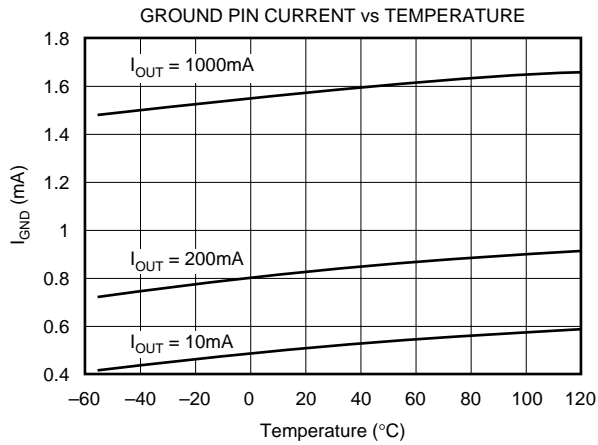

TYPICAL CHARACTERISTICS (Cont.)

For all models, at $T_J = +25^\circ\text{C}$ and $V_{\text{ENABLE}} = 2\text{V}$, unless otherwise noted.

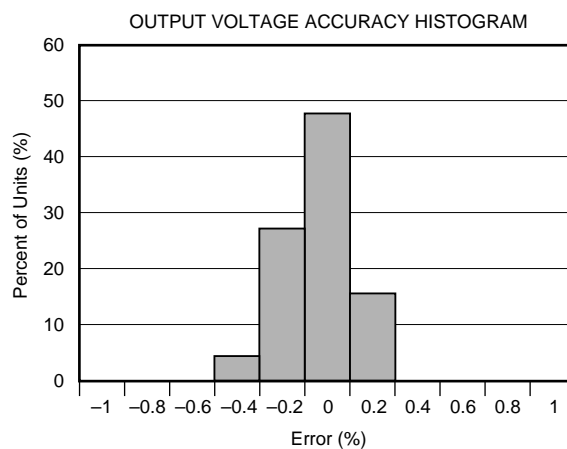
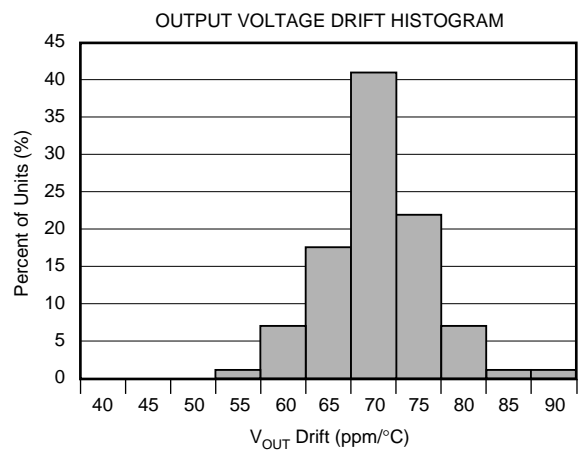
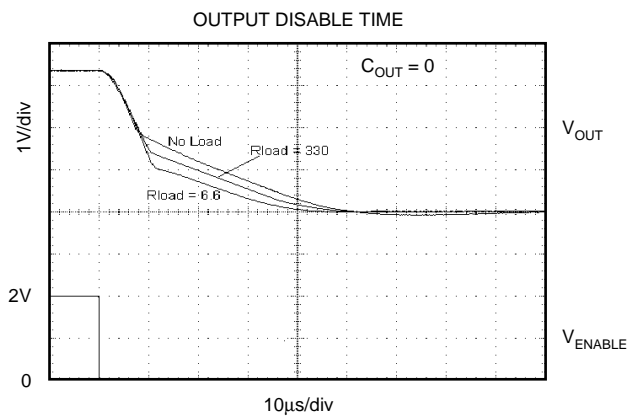
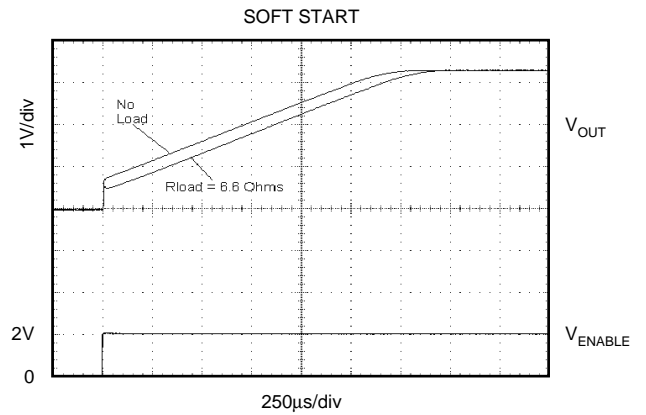
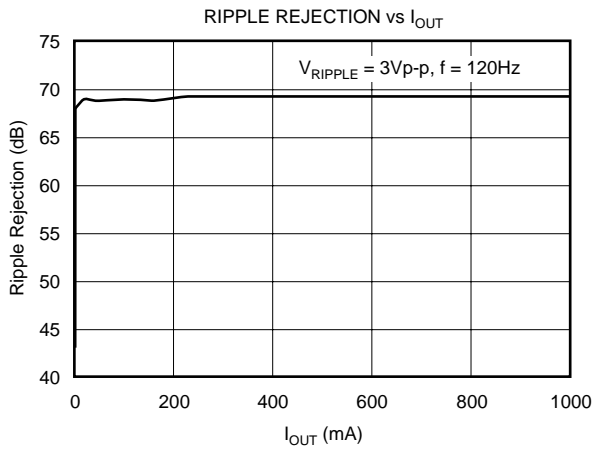

BASIC OPERATION

The REG104 series is a family of LDO (Low DropOut) linear regulators. The family includes five fixed output versions (2.5V to 5.0V) and an adjustable output version. An internal DMOS power device provides low dropout regulation with near constant ground pin current (largely independent of load and dropout conditions) and very fast line and load transient response. All versions include internal current limit and thermal shutdown circuitry.

Figure 1 shows the basic circuit connections for the fixed voltage models. Figure 2 gives the connections for the adjustable output version (REG104A) and example resistor values for some commonly used output voltages. Values for other voltages can be calculated from the equation shown in Figure 2.

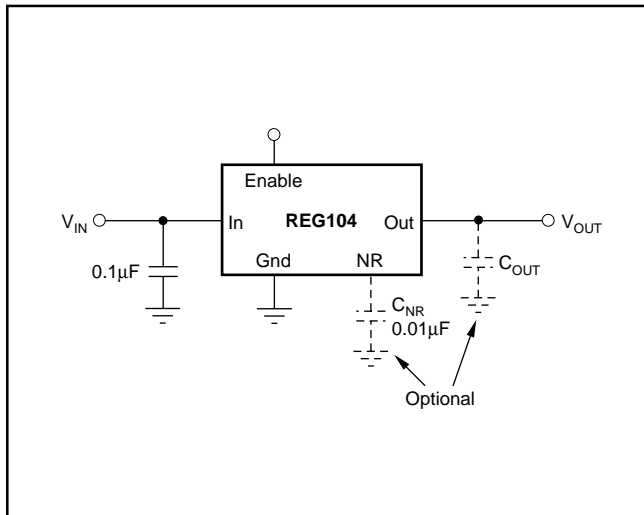

FIGURE 1. Fixed Voltage Nominal Circuit for REG104.

None of the versions require an output capacitor for regulator stability. The REG104 will accept any output capacitor type less than 1µF. For capacitance values larger than 1µF the effective ESR should be greater than 0.1Ω. This minimum ESR value includes parasitics such as printed circuit board traces, solder joints, and sockets. A minimum 0.1µF low ESR capacitor connected to the input supply voltage is recommended.

ENABLE

The Enable pin allows the regulator to be turned on and off. This pin is active HIGH and compatible with standard TTL-CMOS levels. Inputs below 0.5V (max) turn the regulator off and all circuitry is disabled. Under this condition ground-pin current drops to approximately 0.5µA.

When not used, the Enable pin may be connected to V_{IN} . Internal to the part, the Enable pin is connected to an input resistor-zener diode circuit, as shown in Figure 3, creating a nonlinear input impedance.

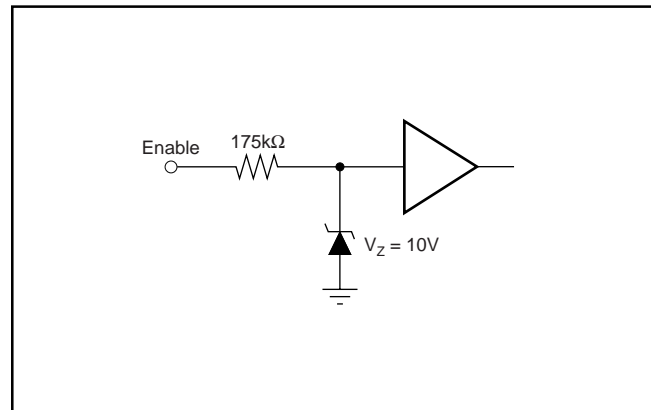

FIGURE 3. Enable Pin Equivalent Input Circuit.

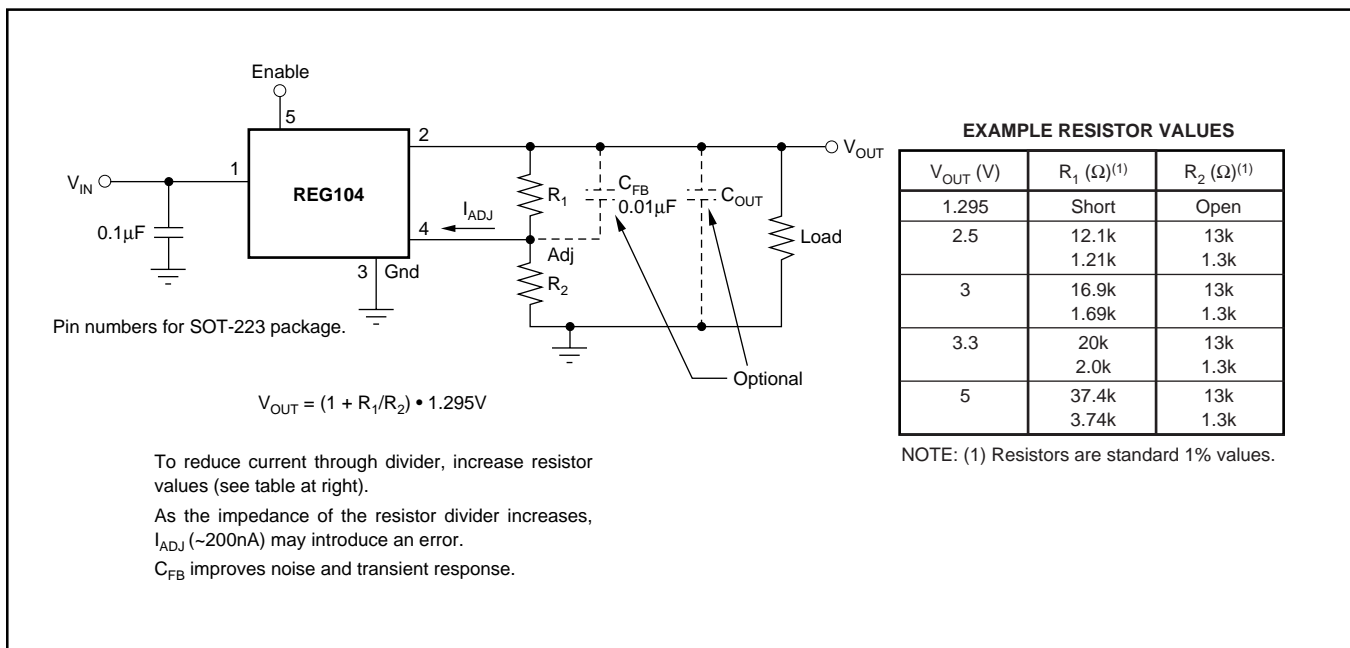

FIGURE 2. Adjustable Voltage Circuit for REG104A.

The Enable Pin Current versus Applied Voltage relationship is shown in Figure 4. When the Enable pin is connected to V_{IN} greater than 10V, a series resistor may be used to limit the current.

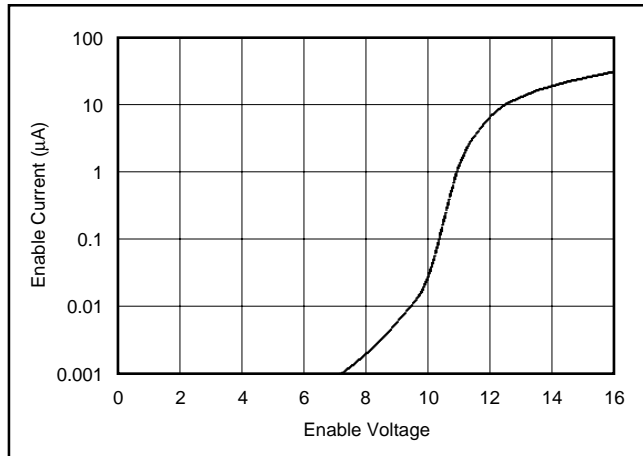

FIGURE 4. Enable Pin Current versus Applied Voltage.

OUTPUT NOISE

A precision band-gap reference is used for the internal reference voltage, V_{REF} , for the REG104. This reference is the dominant noise source within the REG104. It generates approximately $45\mu V_{RMS}$ in the 10Hz to 100kHz bandwidth at the reference output. The regulator control loop gains up the reference noise, so that the noise voltage of the regulator is approximately given by:

$$V_N = 45\mu V_{RMS} \frac{R_1 + R_2}{R_2} = 45\mu V_{RMS} \cdot \frac{V_{OUT}}{V_{REF}}$$

Since the value of V_{REF} is 1.295V, this relationship reduces to:

$$V_N = 35 \frac{\mu V_{RMS}}{V} \cdot V_{OUT}$$

Connecting a capacitor, C_{NR} , from the Noise-Reduction (NR) pin to ground can reduce the output noise voltage. Adding C_{NR} , as shown in Figure 5, forms a low-pass filter for the voltage reference. For $C_{NR} = 10nF$, the total noise in the 10Hz to 100kHz bandwidth is reduced by approximately a factor of 3.5. This noise reduction effect is shown in Figure 6.

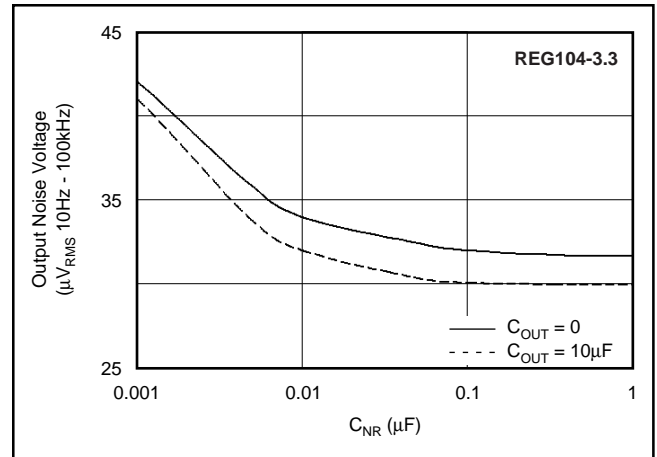

FIGURE 6. Output Noise versus Noise Reduction Capacitor.

The REG104 adjustable version does not have the noise-reduction pin available, however, the adjust pin is the summing junction of the error amplifier. A capacitor, C_{FB} ,

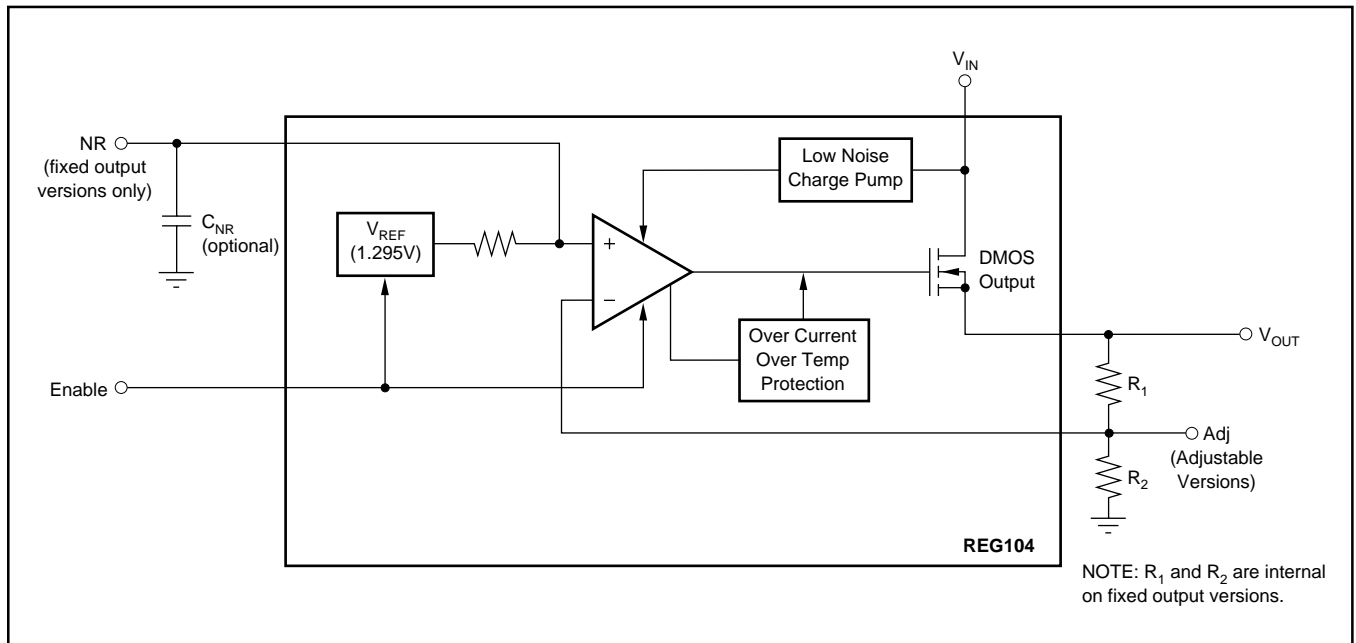

FIGURE 5. Block Diagram.

connected from the output to the adjust pin will reduce both the output noise and the peak error from a load transient. Figure 7 shows improved output noise performance for two capacitor combinations.

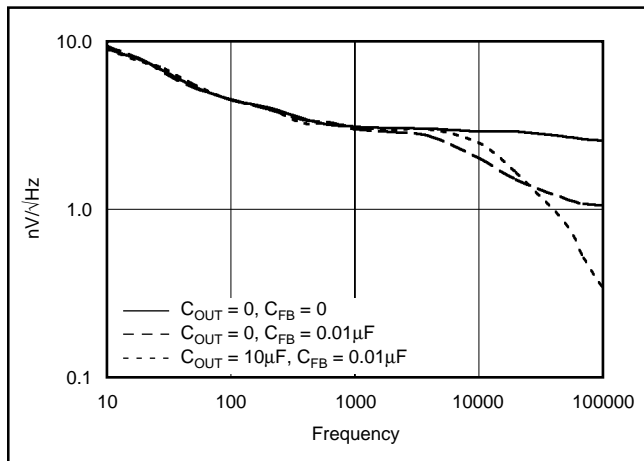

FIGURE 7. Output Noise Density on Adjustable Versions.

The REG104 utilizes an internal charge pump to develop an internal supply voltage sufficient to drive the gate of the DMOS pass element above V_{IN} . The charge-pump switching noise (nominal switching frequency = 2MHz) is not measurable at the output of the regulator.

DROP-OUT VOLTAGE

The REG104 uses an N-channel DMOS as the *pass* element. When the input voltage is within a few hundred millivolts of the output voltage, the DMOS device behaves like a resistor. Therefore, for low values of V_{IN} to V_{OUT} , the regulator's input-to-output resistance is the $R_{DS(ON)}$ of the DMOS pass element (typically 230m Ω). For static (DC) loads, the REG104 will typically maintain regulation down to V_{IN} to V_{OUT} voltage drop of 230mV at full rated output current. In Figure 8, the bottom line (DC dropout) shows the minimum V_{IN} to V_{OUT} voltage drop required to prevent dropout under DC load conditions.

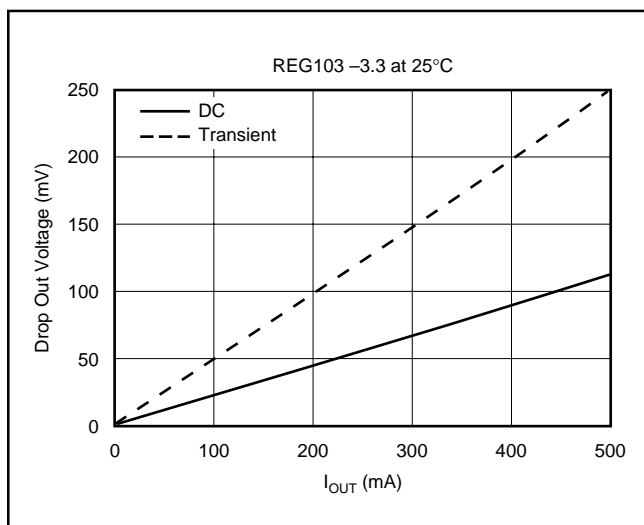

FIGURE 8. Transient and DC Dropout.

For large step changes in load current, the REG104 requires a larger voltage drop across it to avoid degraded transient response. The boundary of this *transient dropout* region is shown as the top line in Figure 8. Values of V_{IN} to V_{OUT} voltage drop above this line insure normal transient response.

In the transient dropout region between *DC* and *Transient*, transient response recovery time increases. The time required to recover from a load transient is a function of both the magnitude and rate of the step change in load current and the available *headroom* V_{IN} to V_{OUT} voltage drop. Under worst-case conditions (full-scale load change with V_{IN} to V_{OUT} voltage drop close to DC dropout levels), the REG104 can take several hundred microseconds to re-enter the specified window of regulation.

TRANSIENT RESPONSE

The REG104 response to transient line and load conditions improves at lower output voltages. The addition of a capacitor (nominal value 10nF) from the output pin to ground may improve the transient response. In the adjustable version, the addition of a capacitor, C_{FB} (nominal value 10nF), from the output to the adjust pin will also improve the transient response.

THERMAL PROTECTION

Power dissipated within the REG104 will cause the junction temperature to rise. The REG104 has thermal shutdown circuitry that protects the regulator from damage. The thermal protection circuitry disables the output when the junction temperature reaches approximately 150°C, allowing the device to cool. When the junction temperature cools to approximately 130°C, the output circuitry is again enabled. Depending on various conditions, the thermal protection circuit may cycle on and off. This limits the dissipation of the regulator, but may have an undesirable effect on the load.

Any tendency to activate the thermal protection circuit indicates excessive power dissipation or an inadequate heat sink. For reliable operation, junction temperature should be limited to 125°C, maximum. To estimate the margin of safety in a complete design (including heat sink), increase the ambient temperature until the thermal protection is triggered. Use worst-case loads and signal conditions. For good reliability, thermal protection should trigger more than 35°C above the maximum expected ambient condition of your application. This produces a worst-case junction temperature of 125°C at the highest expected ambient temperature and worst-case load.

The internal protection circuitry of the REG104 has been designed to protect against overload conditions. It was not intended to replace proper heat sinking. Continuously running the REG104 into thermal shutdown will degrade reliability.

POWER DISSIPATION

The REG104 is available in two different package configurations. The ability to remove heat from the die is different for each package type and, therefore, presents different considerations in the Printed Circuit-Board (PCB) layout. The PCB area around the device that is free of other components moves the heat from the device to the ambient air. While it is difficult-to-impossible to quantify all of the variables in a thermal design of this type, performance data for several configurations are shown in Figure 9. In all cases the PCB copper area is bare copper, free of solder resist mask, and not solder plated. All examples are for 1-ounce copper. Using heavier copper will increase the effectiveness in moving the heat from the device. In those examples where there is copper on both sides of the PCB, no connection has been provided between the two sides. The addition of plated through holes will improve the heat sink effectiveness.

Power dissipation depends on input voltage and load conditions. Power dissipation is equal to the product of the average output current times the voltage across the output element, V_{IN} to V_{OUT} voltage drop.

$$P_D = (V_{IN} - V_{OUT}) \cdot I_{OUT(AVG)}$$

Power dissipation can be minimized by using the lowest possible input voltage necessary to assure the required output voltage.

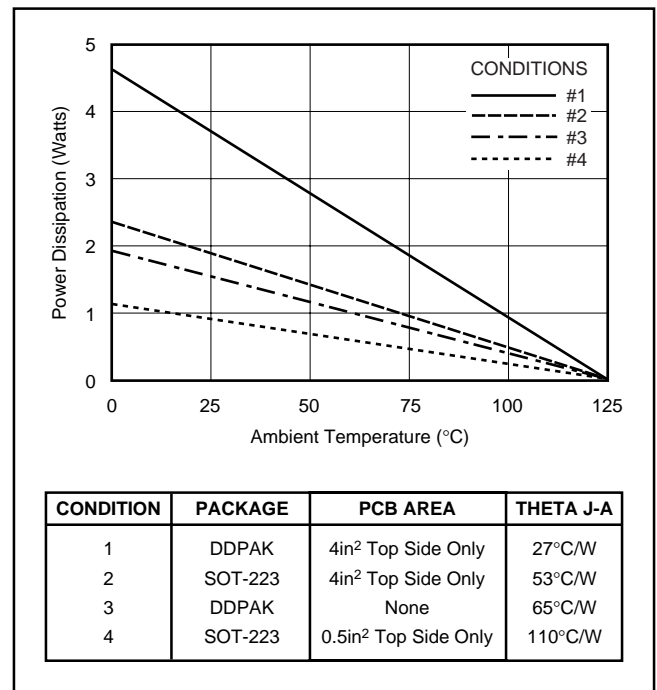

FIGURE 9. Maximum Power Dissipation versus Ambient Temperature for the Various Packages and PCB Heat Sink Configurations.

REGULATOR MOUNTING

The tab of both packages is electrically connected to ground. For best thermal performance, the tab of the DDPAK surface-mount version should be soldered directly to a circuit-board copper area. Increasing the copper area improves heat dissipation. Figure 10 shows typical thermal resistance from junction to ambient as a function of the copper area for the DDPAK. Figure 11 shows the same relationship for the SOT-223.

Although the tabs of the DDPAK and the SOT-223 are electrically grounded, they are not intended to carry any current. The copper pad that acts as a heat sink should be isolated from the rest of the circuit to prevent current flow through the device from the tab to the ground pin. Solder pad footprint recommendations for the various REG104 devices are presented in the Application Bulletin *Solder Pad Recommendations for Surface-Mount Devices* (SBFA015A), available from the Texas Instruments web site (www.ti.com).

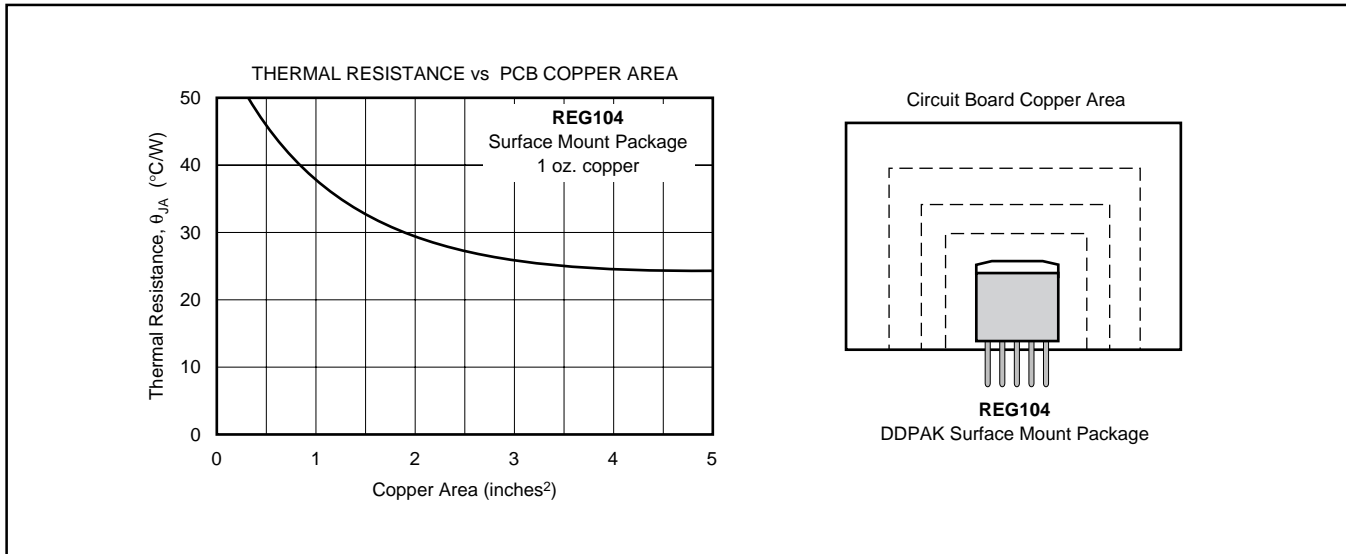

FIGURE 10. Thermal Resistance versus PCB Area for the Five Lead DDPAK.

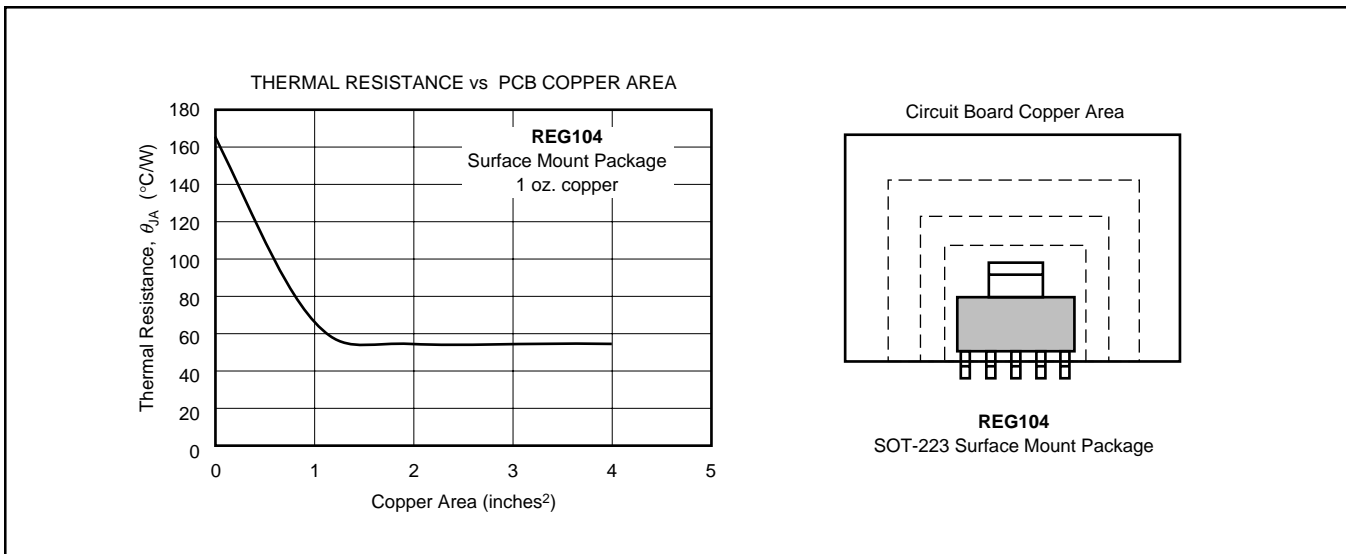

FIGURE 11. Thermal Resistance versus PCB Area for the Five Lead SOT-223.

PACKAGING INFORMATION

Orderable Device	Status ⁽¹⁾	Package Type	Package Drawing	Pins	Package Qty	Eco Plan ⁽²⁾	Lead/Ball Finish	MSL Peak Temp ⁽³⁾
REG104FA-2.5	OBSOLETE	DDPAK/ TO-263	KTT	5		None	Call TI	Call TI
REG104FA-2.5/500	NRND	DDPAK/ TO-263	KTT	5	500	None	Call TI	Level-3-220C-168 HR
REG104FA-2.5KTTT	NRND	DDPAK/ TO-263	KTT	5	50	None	Call TI	Level-3-220C-168 HR
REG104FA-2.7	OBSOLETE	DDPAK/ TO-263	KTT	5		None	Call TI	Call TI
REG104FA-2.7/500	ACTIVE	DDPAK/ TO-263	KTT	5	500	None	Call TI	Level-3-220C-168 HR
REG104FA-2.7KTTT	ACTIVE	DDPAK/ TO-263	KTT	5	50	None	Call TI	Level-3-220C-168 HR
REG104FA-3	OBSOLETE	DDPAK/ TO-263	KTT	5		None	Call TI	Call TI
REG104FA-3.3	OBSOLETE	DDPAK/ TO-263	KTT	5		None	Call TI	Call TI
REG104FA-3.3/500	ACTIVE	DDPAK/ TO-263	KTT	5	500	None	Call TI	Level-3-220C-168 HR
REG104FA-3.3KTTT	ACTIVE	DDPAK/ TO-263	KTT	5	50	None	Call TI	Level-3-220C-168 HR
REG104FA-3/500	NRND	DDPAK/ TO-263	KTT	5	500	None	Call TI	Level-3-220C-168 HR
REG104FA-3KTTT	NRND	DDPAK/ TO-263	KTT	5	50	None	Call TI	Level-3-220C-168 HR
REG104FA-5	OBSOLETE	DDPAK/ TO-263	KTT	5		None	Call TI	Call TI
REG104FA-5/500	ACTIVE	DDPAK/ TO-263	KTT	5	500	None	Call TI	Level-3-220C-168 HR
REG104FA-5KTTT	ACTIVE	DDPAK/ TO-263	KTT	5	50	None	Call TI	Level-3-220C-168 HR
REG104FA-A	OBSOLETE	DDPAK/ TO-263	KTT	5		None	Call TI	Call TI
REG104FA-A/500	ACTIVE	DDPAK/ TO-263	KTT	5	500	None	Call TI	Level-3-220C-168 HR
REG104FA-AKTTT	ACTIVE	DDPAK/ TO-263	KTT	5	50	None	Call TI	Level-3-220C-168 HR
REG104GA-2.5	NRND	SOP	DCQ	6	78	None	Call TI	Level-3-240C-168 HR
REG104GA-2.5/2K5	NRND	SOP	DCQ	6	2500	None	Call TI	Level-3-240C-168 HR
REG104GA-2.7	ACTIVE	SOP	DCQ	6	78	None	Call TI	Level-3-240C-168 HR
REG104GA-2.7/2K5	ACTIVE	SOP	DCQ	6	2500	None	Call TI	Level-3-240C-168 HR
REG104GA-3	NRND	SOP	DCQ	6	78	None	Call TI	Level-3-240C-168 HR
REG104GA-3.3	ACTIVE	SOP	DCQ	6	78	None	Call TI	Level-3-240C-168 HR
REG104GA-3.3/2K5	ACTIVE	SOP	DCQ	6	2500	None	Call TI	Level-3-240C-168 HR
REG104GA-3/2K5	NRND	SOP	DCQ	6	2500	None	Call TI	Level-3-240C-168 HR
REG104GA-5	ACTIVE	SOP	DCQ	6	78	None	Call TI	Level-3-240C-168 HR
REG104GA-5/2K5	ACTIVE	SOP	DCQ	6	2500	None	Call TI	Level-3-240C-168 HR
REG104GA-A	ACTIVE	SOP	DCQ	6	78	None	Call TI	Level-3-240C-168 HR

Orderable Device	Status ⁽¹⁾	Package Type	Package Drawing	Pins	Package Qty	Eco Plan ⁽²⁾	Lead/Ball Finish	MSL Peak Temp ⁽³⁾
REG104GA-A/2K5	ACTIVE	SOP	DCQ	6	2500	None	Call TI	Level-3-240C-168 HR
REG104GA-A/2K5G4	ACTIVE	SOP	DCQ	6	2500	Green (RoHS & no Sb/Br)	Call TI	Level-2-260C-1 YEAR

⁽¹⁾ The marketing status values are defined as follows:

ACTIVE: Product device recommended for new designs.

LIFEBUY: TI has announced that the device will be discontinued, and a lifetime-buy period is in effect.

NRND: Not recommended for new designs. Device is in production to support existing customers, but TI does not recommend using this part in a new design.

PREVIEW: Device has been announced but is not in production. Samples may or may not be available.

OBsolete: TI has discontinued the production of the device.

⁽²⁾ Eco Plan - May not be currently available - please check <http://www.ti.com/productcontent> for the latest availability information and additional product content details.

None: Not yet available Lead (Pb-Free).

Pb-Free (RoHS): TI's terms "Lead-Free" or "Pb-Free" mean semiconductor products that are compatible with the current RoHS requirements for all 6 substances, including the requirement that lead not exceed 0.1% by weight in homogeneous materials. Where designed to be soldered at high temperatures, TI Pb-Free products are suitable for use in specified lead-free processes.

Green (RoHS & no Sb/Br): TI defines "Green" to mean "Pb-Free" and in addition, uses package materials that do not contain halogens, including bromine (Br) or antimony (Sb) above 0.1% of total product weight.

⁽³⁾ MSL, Peak Temp. -- The Moisture Sensitivity Level rating according to the JEDEC industry standard classifications, and peak solder temperature.

Important Information and Disclaimer: The information provided on this page represents TI's knowledge and belief as of the date that it is provided. TI bases its knowledge and belief on information provided by third parties, and makes no representation or warranty as to the accuracy of such information. Efforts are underway to better integrate information from third parties. TI has taken and continues to take reasonable steps to provide representative and accurate information but may not have conducted destructive testing or chemical analysis on incoming materials and chemicals. TI and TI suppliers consider certain information to be proprietary, and thus CAS numbers and other limited information may not be available for release.

In no event shall TI's liability arising out of such information exceed the total purchase price of the TI part(s) at issue in this document sold by TI to Customer on an annual basis.

DCQ (R-PDSO-G6)

PLASTIC SMALL-OUTLINE

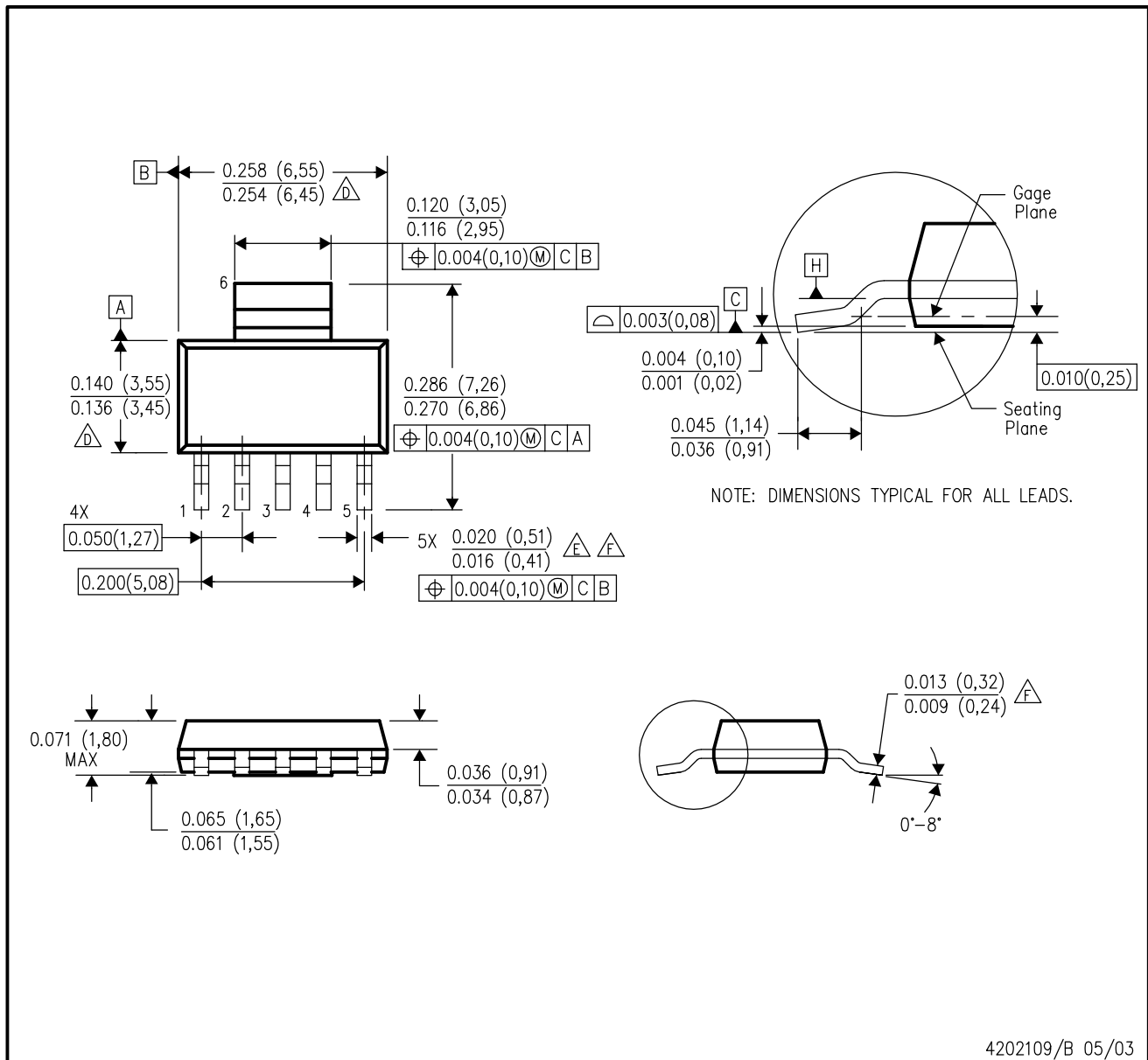

- NOTES:
- A. All linear dimensions are in inches (millimeters).
 - B. This drawing is subject to change without notice.
 - C. Controlling dimension in inches.
 - $\triangle D$ Body length and width dimensions are determined at the outermost extremes of the plastic body exclusive of mold flash, tie bar burrs, gate burrs, and interlead flash, but including any mismatch between the top and the bottom of the plastic body.
 - $\triangle E$ Lead width dimension does not include dambar protrusion.
 - $\triangle F$ Lead width and thickness dimensions apply to solder plated leads.
 - G. Interlead flash allow 0.008 inch max.
 - H. Gate burr/protrusion max. 0.006 inch.
 - I. Datums A and B are to be determined at Datum H.
 - J. Package dimensions per JEDEC outline drawing TO-261, issue B, dated Feb. 1999. This variation is not yet included.

KTT (R-PSFM-G5)

PLASTIC FLANGE-MOUNT PACKAGE

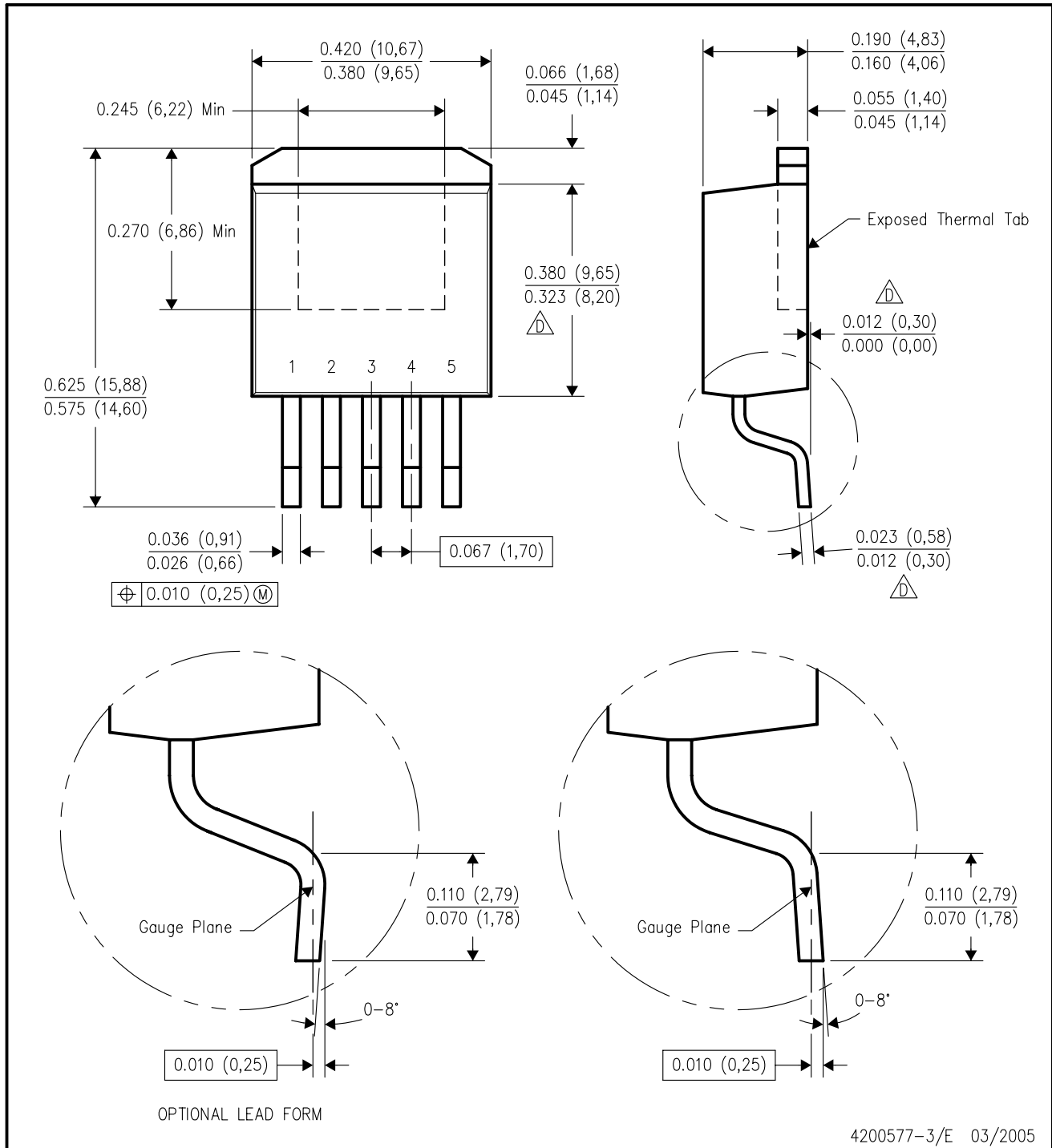

- NOTES:
- A. All linear dimensions are in inches (millimeters).
 - B. This drawing is subject to change without notice.
 - C. Body dimensions do not include mold flash or protrusion. Mold flash or protrusion not to exceed 0.005 (0,13) per side.
- △ Falls within JEDEC TO-263 variation BA, except minimum lead thickness, maximum seating height, and minimum body length.

IMPORTANT NOTICE

Texas Instruments Incorporated and its subsidiaries (TI) reserve the right to make corrections, modifications, enhancements, improvements, and other changes to its products and services at any time and to discontinue any product or service without notice. Customers should obtain the latest relevant information before placing orders and should verify that such information is current and complete. All products are sold subject to TI's terms and conditions of sale supplied at the time of order acknowledgment.

TI warrants performance of its hardware products to the specifications applicable at the time of sale in accordance with TI's standard warranty. Testing and other quality control techniques are used to the extent TI deems necessary to support this warranty. Except where mandated by government requirements, testing of all parameters of each product is not necessarily performed.

TI assumes no liability for applications assistance or customer product design. Customers are responsible for their products and applications using TI components. To minimize the risks associated with customer products and applications, customers should provide adequate design and operating safeguards.

TI does not warrant or represent that any license, either express or implied, is granted under any TI patent right, copyright, mask work right, or other TI intellectual property right relating to any combination, machine, or process in which TI products or services are used. Information published by TI regarding third-party products or services does not constitute a license from TI to use such products or services or a warranty or endorsement thereof. Use of such information may require a license from a third party under the patents or other intellectual property of the third party, or a license from TI under the patents or other intellectual property of TI.

Reproduction of information in TI data books or data sheets is permissible only if reproduction is without alteration and is accompanied by all associated warranties, conditions, limitations, and notices. Reproduction of this information with alteration is an unfair and deceptive business practice. TI is not responsible or liable for such altered documentation.

Resale of TI products or services with statements different from or beyond the parameters stated by TI for that product or service voids all express and any implied warranties for the associated TI product or service and is an unfair and deceptive business practice. TI is not responsible or liable for any such statements.

Following are URLs where you can obtain information on other Texas Instruments products and application solutions:

Products		Applications	
Amplifiers	amplifier.ti.com	Audio	www.ti.com/audio
Data Converters	dataconverter.ti.com	Automotive	www.ti.com/automotive
DSP	dsp.ti.com	Broadband	www.ti.com/broadband
Interface	interface.ti.com	Digital Control	www.ti.com/digitalcontrol
Logic	logic.ti.com	Military	www.ti.com/military
Power Mgmt	power.ti.com	Optical Networking	www.ti.com/opticalnetwork
Microcontrollers	microcontroller.ti.com	Security	www.ti.com/security
		Telephony	www.ti.com/telephony
		Video & Imaging	www.ti.com/video
		Wireless	www.ti.com/wireless

Mailing Address: Texas Instruments
Post Office Box 655303 Dallas, Texas 75265

This datasheet has been download from:

www.datasheetcatalog.com

Datasheets for electronics components.