

IRG4PC30KD

INSULATED GATE BIPOLAR TRANSISTOR WITH
ULTRAFAST SOFT RECOVERY DIODE

Short Circuit Rated
UltraFast IGBT

Features

- High short circuit rating optimized for motor control, $t_{sc} = 10\mu s$, @360V V_{CE} (start), $T_J = 125^\circ C$, $V_{GE} = 15V$
- Combines low conduction losses with high switching speed
- Tighter parameter distribution and higher efficiency than previous generations
- IGBT co-packaged with HEXFRED™ ultrafast, ultrasoft recovery antiparallel diodes

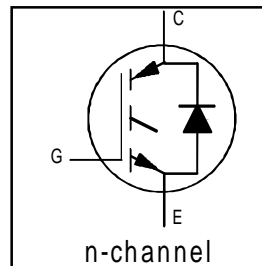

| |
|-----------------------------------|
| $V_{CES} = 600V$ |
| $V_{CE(on)} \text{ typ.} = 2.21V$ |
| @ $V_{GE} = 15V, I_C = 16A$ |

Benefits

- Latest generation 4 IGBTs offer highest power density motor controls possible
- HEXFRED™ diodes optimized for performance with IGBTs. Minimized recovery characteristics reduce noise, EMI and switching losses
- This part replaces the IRGBC30KD2 and IRGBC30MD2 products
- For hints see design tip 97003

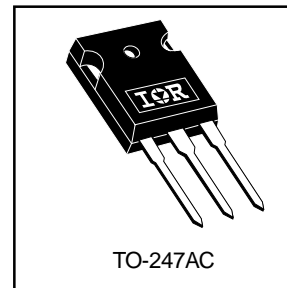

Absolute Maximum Ratings

| | Parameter | Max. | Units |
|---------------------------|------------------------------------|-----------------------------------|------------|
| V_{CES} | Collector-to-Emitter Voltage | 600 | V |
| $I_C @ T_C = 25^\circ C$ | Continuous Collector Current | 28 | A |
| $I_C @ T_C = 100^\circ C$ | Continuous Collector Current | 16 | |
| I_{CM} | Pulsed Collector Current ① | 58 | |
| I_{LM} | Clamped Inductive Load Current ② | 58 | |
| $I_F @ T_C = 100^\circ C$ | Diode Continuous Forward Current | 12 | |
| I_{FM} | Diode Maximum Forward Current | 58 | |
| t_{sc} | Short Circuit Withstand Time | 10 | μs |
| V_{GE} | Gate-to-Emitter Voltage | ± 20 | V |
| $P_D @ T_C = 25^\circ C$ | Maximum Power Dissipation | 100 | W |
| $P_D @ T_C = 100^\circ C$ | Maximum Power Dissipation | 42 | |
| T_J | Operating Junction and | -55 to +150 | $^\circ C$ |
| T_{STG} | Storage Temperature Range | | |
| | Soldering Temperature, for 10 sec. | 300 (0.063 in. (1.6mm) from case) | |
| | Mounting Torque, 6-32 or M3 Screw. | 10 lbf•in (1.1 N•m) | |

Thermal Resistance

| | Parameter | Min. | Typ. | Max. | Units |
|-----------------|---|------|----------|------|--------------|
| $R_{\theta JC}$ | Junction-to-Case - IGBT | — | — | 1.2 | $^\circ C/W$ |
| $R_{\theta JC}$ | Junction-to-Case - Diode | — | — | 2.5 | |
| $R_{\theta CS}$ | Case-to-Sink, flat, greased surface | — | 0.24 | — | |
| $R_{\theta JA}$ | Junction-to-Ambient, typical socket mount | — | — | 40 | |
| Wt | Weight | — | 6 (0.21) | — | g (oz) |

IRG4PC30KD

International
IR Rectifier

Electrical Characteristics @ $T_J = 25^\circ\text{C}$ (unless otherwise specified)

| | Parameter | Min. | Typ. | Max. | Units | Conditions |
|---------------------------------|---|------|------|-----------|----------------------|---|
| $V_{(BR)CES}$ | Collector-to-Emitter Breakdown Voltage ^③ | 600 | — | — | V | $V_{GE} = 0V, I_C = 250\mu A$ |
| $\Delta V_{(BR)CES}/\Delta T_J$ | Temperature Coeff. of Breakdown Voltage | — | 0.54 | — | V/ $^\circ\text{C}$ | $V_{GE} = 0V, I_C = 1.0mA$ |
| $V_{CE(on)}$ | Collector-to-Emitter Saturation Voltage | — | 2.21 | 2.7 | V | $I_C = 16A$ $I_C = 28A$ $I_C = 16A, T_J = 150^\circ\text{C}$ |
| | | — | 2.88 | — | | |
| | | — | 2.36 | — | | |
| $V_{GE(th)}$ | Gate Threshold Voltage | 3.0 | — | 6.0 | | $V_{CE} = V_{GE}, I_C = 250\mu A$ |
| $\Delta V_{GE(th)}/\Delta T_J$ | Temperature Coeff. of Threshold Voltage | — | -12 | — | mV/ $^\circ\text{C}$ | $V_{CE} = V_{GE}, I_C = 250\mu A$ |
| g_{fe} | Forward Transconductance ^④ | 5.4 | 8.1 | — | S | $V_{CE} = 100V, I_C = 16A$ |
| I_{CES} | Zero Gate Voltage Collector Current | — | — | 250 | μA | $V_{GE} = 0V, V_{CE} = 600V$ $V_{GE} = 0V, V_{CE} = 600V, T_J = 150^\circ\text{C}$ |
| | | — | — | 2500 | | |
| V_{FM} | Diode Forward Voltage Drop | — | 1.4 | 1.7 | V | $I_C = 12A$ $I_C = 12A, T_J = 150^\circ\text{C}$ |
| | | — | 1.3 | 1.6 | | |
| I_{GES} | Gate-to-Emitter Leakage Current | — | — | ± 100 | nA | $V_{GE} = \pm 20V$ |

Switching Characteristics @ $T_J = 25^\circ\text{C}$ (unless otherwise specified)

| | Parameter | Min. | Typ. | Max. | Units | Conditions |
|------------------|--|------|------|------|------------|---|
| Q_g | Total Gate Charge (turn-on) | — | 67 | 100 | nC | $I_C = 16A$ $V_{CC} = 400V$ $V_{GE} = 15V$ See Fig.8 |
| Q_{ge} | Gate - Emitter Charge (turn-on) | — | 11 | 16 | | |
| Q_{gc} | Gate - Collector Charge (turn-on) | — | 25 | 37 | | |
| $t_{d(on)}$ | Turn-On Delay Time | — | 60 | — | ns | $T_J = 25^\circ\text{C}$ $I_C = 16A, V_{CC} = 480V$ $V_{GE} = 15V, R_G = 23\Omega$ |
| t_r | Rise Time | — | 42 | — | | |
| $t_{d(off)}$ | Turn-Off Delay Time | — | 160 | 250 | | |
| t_f | Fall Time | — | 80 | 120 | | |
| E_{on} | Turn-On Switching Loss | — | 0.60 | — | mJ | Energy losses include "tail" and diode reverse recovery See Fig. 9,10,14 |
| E_{off} | Turn-Off Switching Loss | — | 0.58 | — | | |
| E_{ts} | Total Switching Loss | — | 1.18 | 1.6 | | |
| t_{sc} | Short Circuit Withstand Time | 10 | — | — | μs | $V_{CC} = 360V, T_J = 125^\circ\text{C}$ $V_{GE} = 15V, R_G = 10\Omega, V_{CPK} < 500V$ |
| $t_{d(on)}$ | Turn-On Delay Time | — | 58 | — | ns | $T_J = 150^\circ\text{C}$, $I_C = 16A, V_{CC} = 480V$ $V_{GE} = 15V, R_G = 23\Omega$ Energy losses include "tail" and diode reverse recovery See Fig. 11,14 |
| t_r | Rise Time | — | 42 | — | | |
| $t_{d(off)}$ | Turn-Off Delay Time | — | 210 | — | | |
| t_f | Fall Time | — | 160 | — | | |
| E_{ts} | Total Switching Loss | — | 1.69 | — | mJ | |
| L_E | Internal Emitter Inductance | — | 13 | — | nH | Measured 5mm from package |
| C_{ies} | Input Capacitance | — | 920 | — | pF | $V_{GE} = 0V$ $V_{CC} = 30V$ $f = 1.0MHz$ See Fig. 7 |
| C_{oes} | Output Capacitance | — | 110 | — | | |
| C_{res} | Reverse Transfer Capacitance | — | 27 | — | | |
| t_{rr} | Diode Reverse Recovery Time | — | 42 | 60 | ns | $T_J = 25^\circ\text{C}$ See Fig. 14 $T_J = 125^\circ\text{C}$ 14 |
| | | — | 80 | 120 | | |
| I_{rr} | Diode Peak Reverse Recovery Current | — | 3.5 | 6.0 | A | $T_J = 25^\circ\text{C}$ See Fig. 15 $T_J = 125^\circ\text{C}$ 15 |
| | | — | 5.6 | 10 | | |
| Q_{rr} | Diode Reverse Recovery Charge | — | 80 | 180 | nC | $T_J = 25^\circ\text{C}$ See Fig. 16 $T_J = 125^\circ\text{C}$ 16 |
| | | — | 220 | 600 | | |
| $di_{(rec)M}/dt$ | Diode Peak Rate of Fall of Recovery During t_b | — | 180 | — | A/ μs | $T_J = 25^\circ\text{C}$ See Fig. 17 $T_J = 125^\circ\text{C}$ 17 |
| | | — | 160 | — | | |

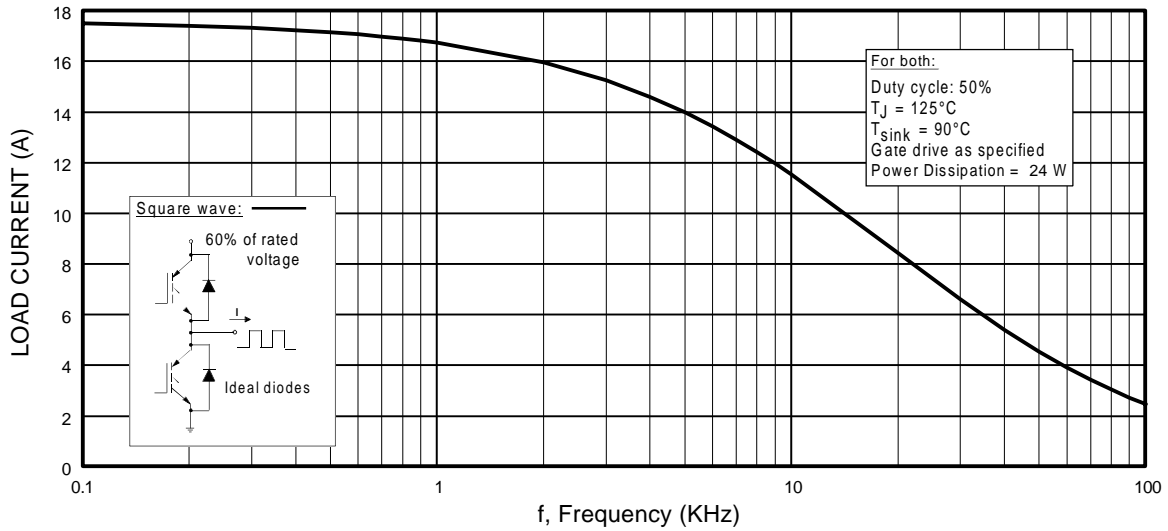

Fig. 1 - Typical Load Current vs. Frequency
 (Load Current = I_{RMS} of fundamental)

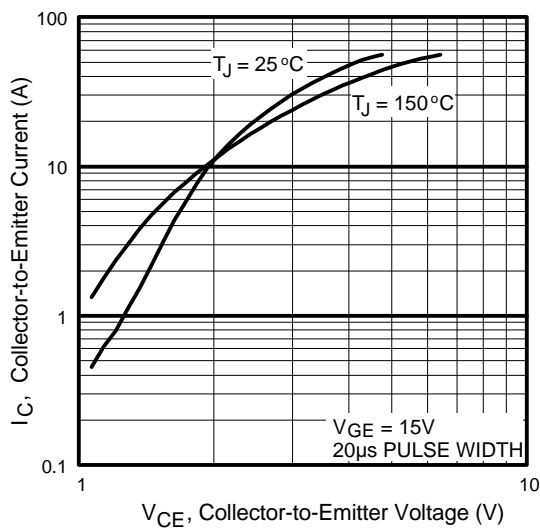

Fig. 2 - Typical Output Characteristics

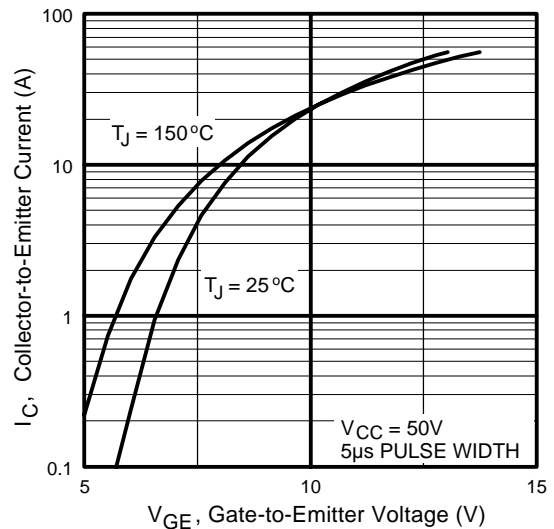

Fig. 3 - Typical Transfer Characteristics

IRG4PC30KD

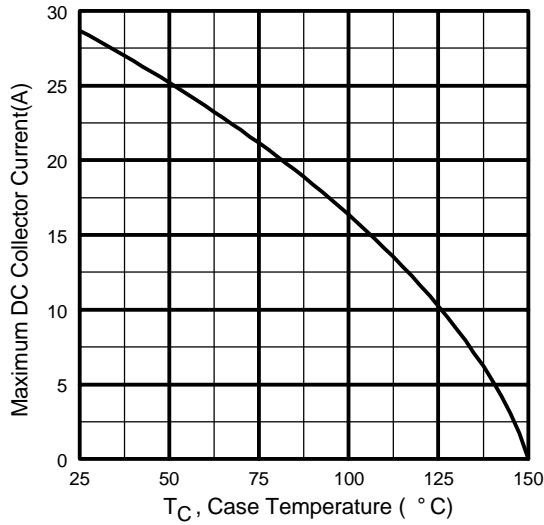

Fig. 4 - Maximum Collector Current vs. Case Temperature

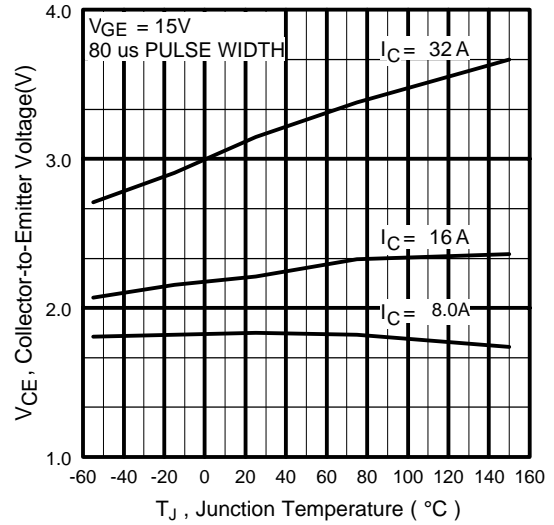

Fig. 5 - Typical Collector-to-Emitter Voltage vs. Junction Temperature

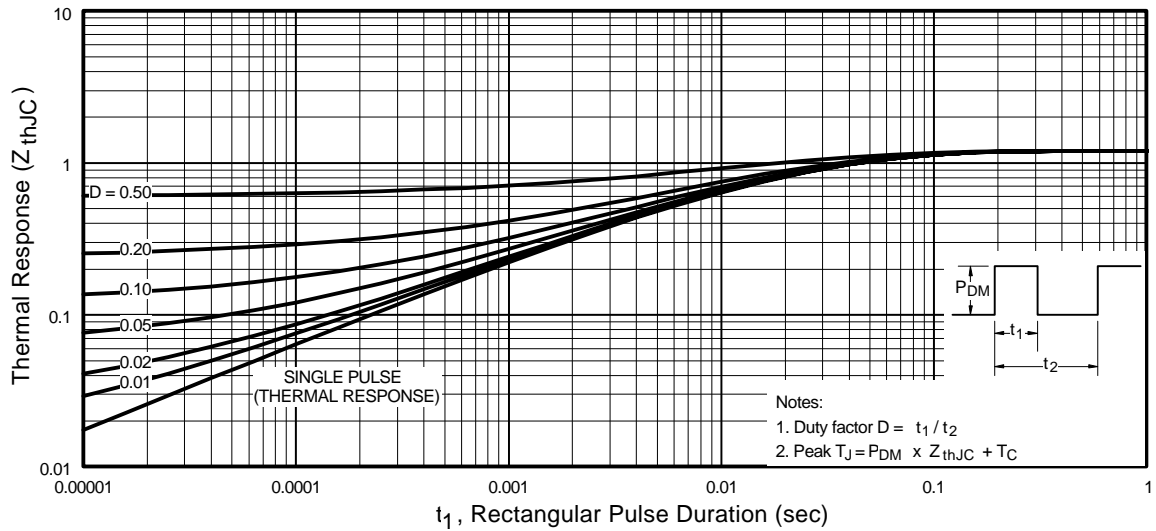

Fig. 6 - Maximum Effective Transient Thermal Impedance, Junction-to-Case

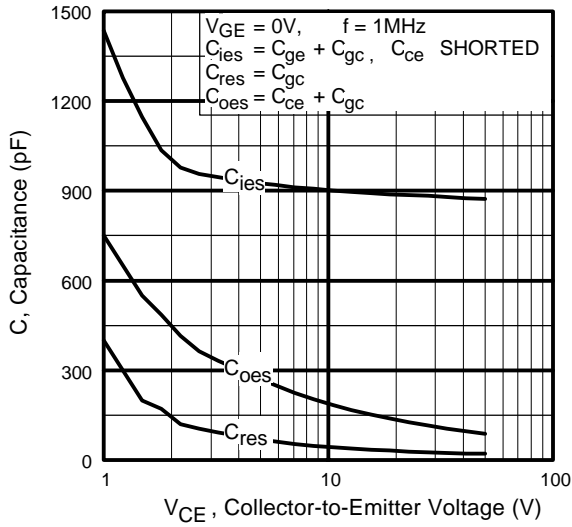

Fig. 7 - Typical Capacitance vs. Collector-to-Emitter Voltage

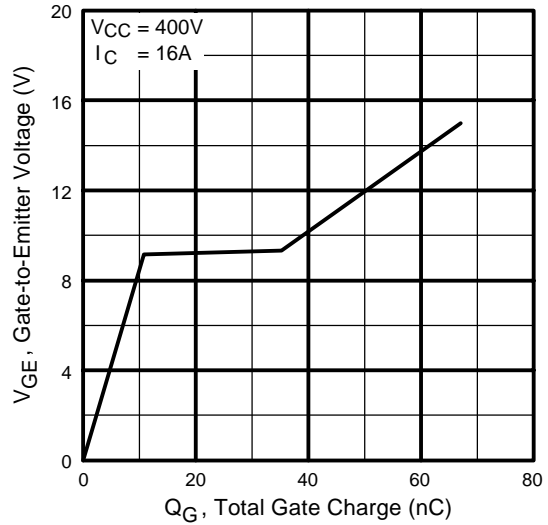

Fig. 8 - Typical Gate Charge vs. Gate-to-Emitter Voltage

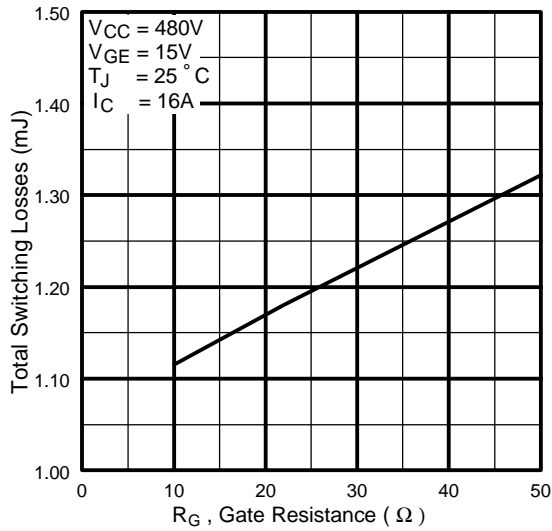

Fig. 9 - Typical Switching Losses vs. Gate Resistance

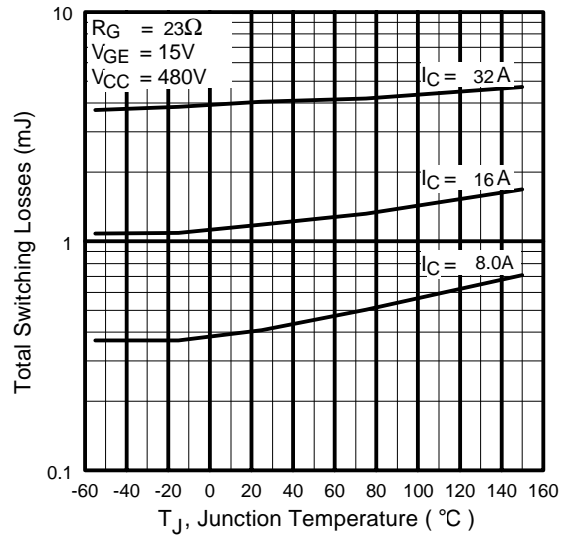

Fig. 10 - Typical Switching Losses vs. Junction Temperature

IRG4PC30KD

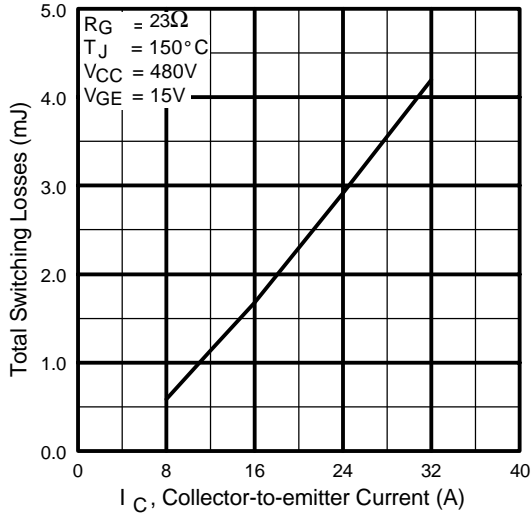

Fig. 11 - Typical Switching Losses vs. Collector-to-Emitter Current

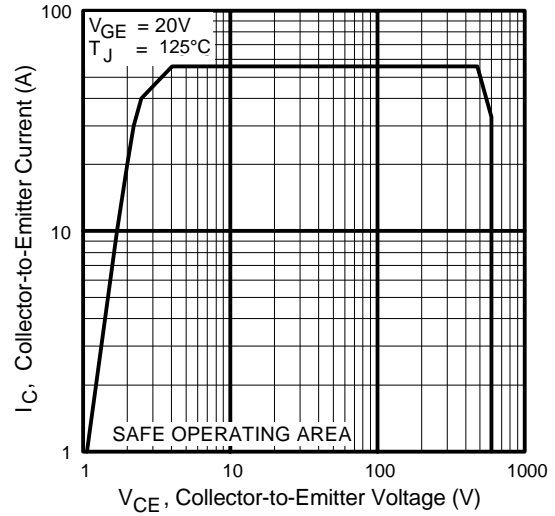

Fig. 12 - Turn-Off SOA

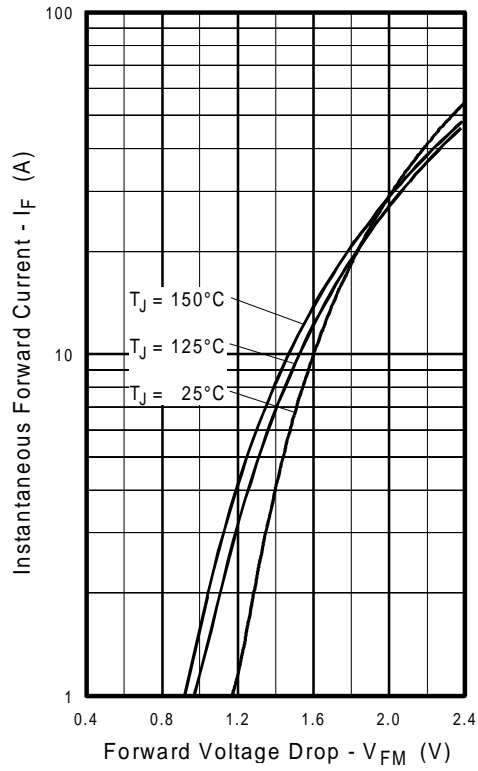

Fig. 13 - Maximum Forward Voltage Drop vs. Instantaneous Forward Current

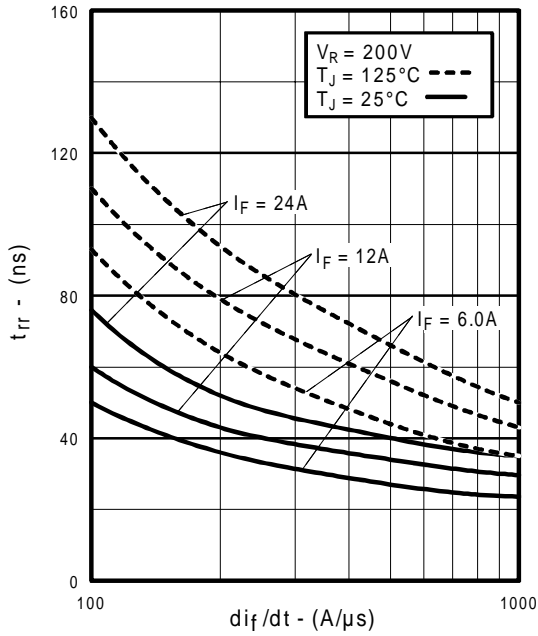

Fig. 14 - Typical Reverse Recovery vs. di_f/dt

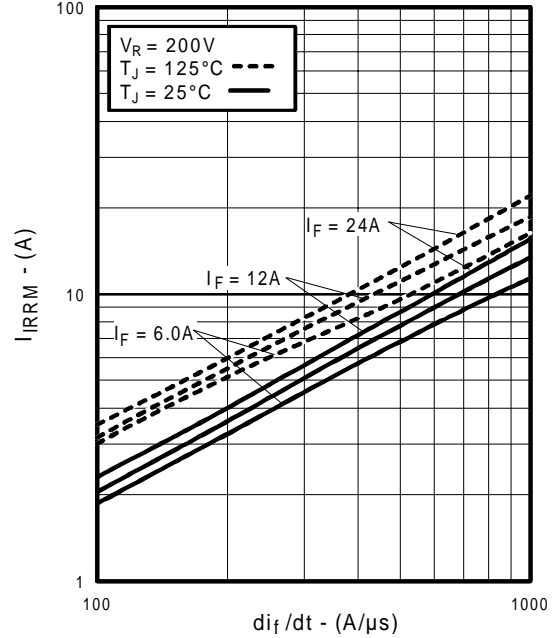

Fig. 15 - Typical Recovery Current vs. di_f/dt

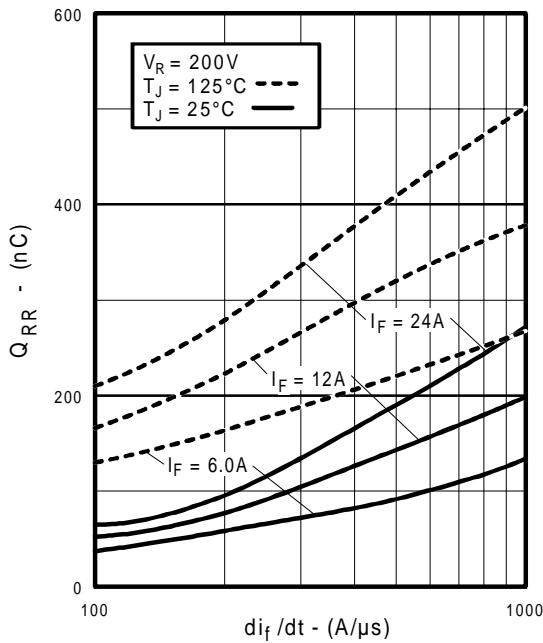

Fig. 16 - Typical Stored Charge vs. di_f/dt

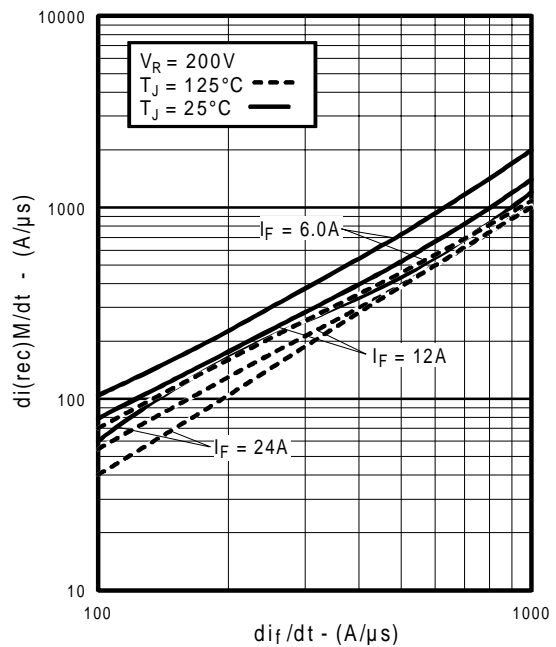

Fig. 17 - Typical $di_{(rec)M}/dt$ vs. di_f/dt

IRG4PC30KD

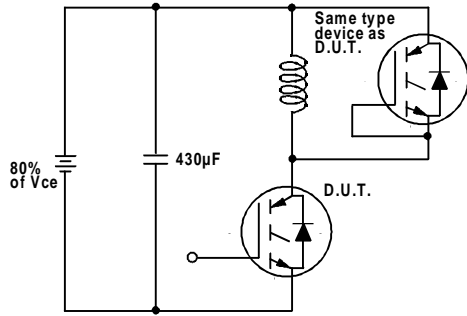

Fig. 18a - Test Circuit for Measurement of I_{LM} , E_{on} , $E_{off}(\text{diode})$, t_{rr} , Q_{rr} , I_{rr} , $t_{d(on)}$, t_r , $t_{d(off)}$, t_f

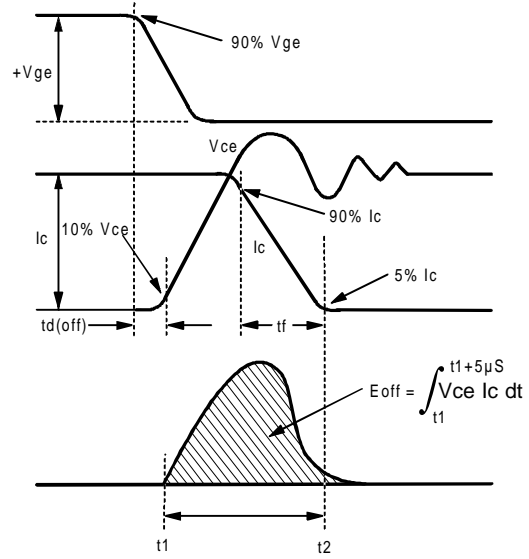

Fig. 18b - Test Waveforms for Circuit of Fig. 18a, Defining E_{off} , $t_{d(off)}$, t_f

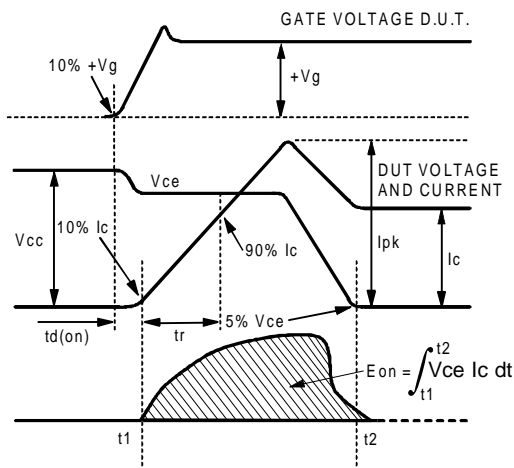

Fig. 18c - Test Waveforms for Circuit of Fig. 18a, Defining E_{on} , $t_{d(on)}$, t_r

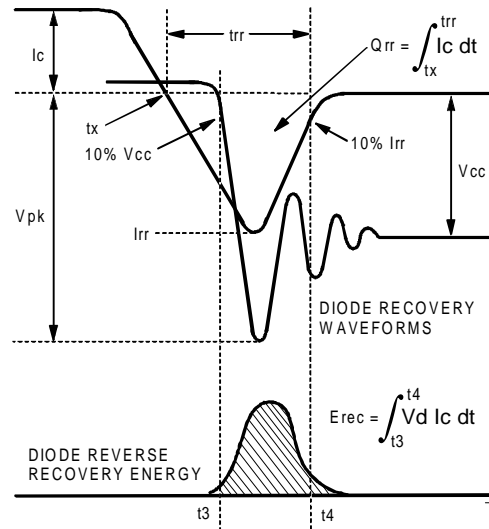

Fig. 18d - Test Waveforms for Circuit of Fig. 18a, Defining E_{rec} , t_{rr} , Q_{rr} , I_{rr}

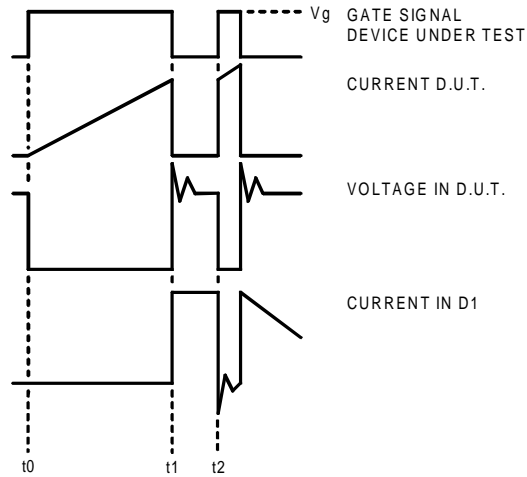

Figure 18e. Macro Waveforms for Figure 18a's Test Circuit

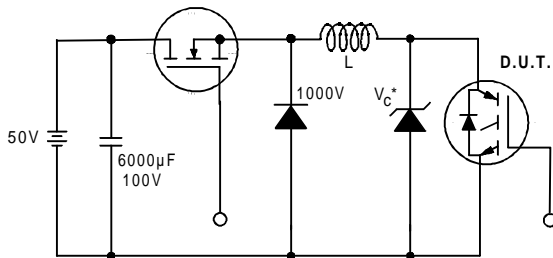

Figure 19. Clamped Inductive Load Test Circuit

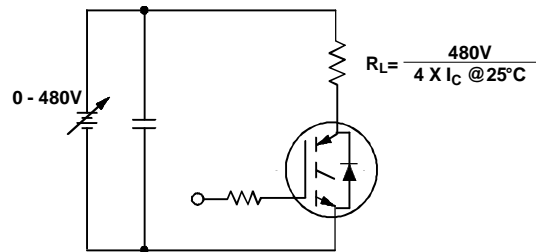

Figure 20. Pulsed Collector Current Test Circuit

IRG4PC30KD

Notes:

- ① Repetitive rating: $V_{GE}=20V$; pulse width limited by maximum junction temperature (figure 20)
- ② $V_{CC}=80\%(V_{CES})$, $V_{GE}=20V$, $L=10\mu H$, $R_G=23\Omega$ (figure 19)
- ③ Pulse width $\leq 80\mu s$; duty factor $\leq 0.1\%$.
- ④ Pulse width $5.0\mu s$, single shot.

Case Outline — TO-247AC

