

Plugs for pluggable terminal blocks / EC & ESD series

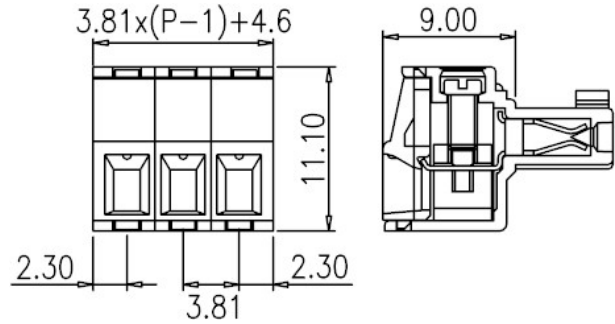

EC381V

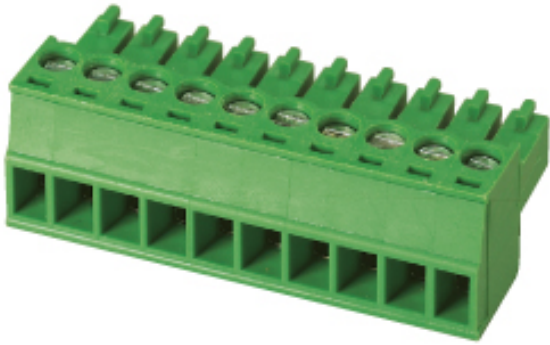

Pitch: 3.81mm

Approval	UL	
Technical Data	UL	IEC
Rated voltage	300V	130V
Rated current	8A	8A
Wire range		1.5mm ²
Solid wire (AWG)	28~14	
Stranded wire (AWG/mm ²)	28~14	
Rated surge voltage (UL/IEC/Max.)	1.6 / 1.25 / 3 KV	
Torque (Lb-in)	1.7	
Screw	M2	
Wire strip length	6~7mm	
Pole	Cat. No.	
02	EC381V-02P	
:	:	
:	:	
24	EC381V-24P	

TEL: +886-2-2908-0614

FAX: +886-2-2908-8549

E-mail: infor@dinkle.com.tw