

TPS54A20EVM-770, 10-A, SWIFT™ Regulator Evaluation Module

This user's guide contains information for the TPS54A20EVM-770 evaluation module (PWR770) as well as for the TPS54A20 dc/dc converter. Also included are the performance specifications, the schematic, and the bill of materials for the TPS54A20EVM-770.

Contents

1	Introduction	2
2	Test Setup and Results	3
3	Board Layout.....	13
4	Schematic and Bill of Materials.....	19

List of Figures

1	TPS54A20EVM-770 Efficiency.....	5
2	TPS54A20EVM-770 Low Current Efficiency	5
3	TPS54A20EVM-770 Load Regulation	6
4	TPS54A20EVM-770 Line Regulation	6
5	TPS54A20EVM-770 Transient Response	7
6	TPS54A20EVM-770 Loop Response	7
7	TPS54A20EVM-770 Output Ripple, 0 A Load	8
8	TPS54A20EVM-770 Output Ripple, 5 A Load	8
9	TPS54A20EVM-770 Output Ripple, 10 A Load.....	9
10	TPS54A20EVM-770 Input Ripple, 0 A Load	9
11	TPS54A20EVM-770 Input Ripple, 5 A Load.....	10
12	TPS54A20EVM-770 Input Ripple, 10 A Load	10
13	TPS54A20EVM-770 Start-Up Relative to V_{IN}	11
14	TPS54A20EVM-770 Start-Up Relative to Enable.....	11
15	Thermal Image.....	12
16	TPS54A20EVM-770 Top-Side Assembly	14
17	TPS54A20EVM-770 Top-Side Layout.....	15
18	TPS54A20EVM-770 Internal Layer-1 Layout.....	16
19	TPS54A20EVM-770 Internal Layer-2 Layout.....	17
20	TPS54A20EVM-770 Bottom-Side Layout	18
21	TPS54A20EVM-770 Schematic	19

List of Tables

1	Input Voltage and Output Current Summary	2
2	TPS54A20EVM-770 Performance Specification Summary	2
3	EVM Connectors and Test Points	4
4	TPS54A20EVM-770 Bill of Materials	20

1 Introduction

1.1 Background

The TPS54A20 dc/dc converter is a two-phase synchronous series capacitor buck converter designed to provide up to a 10-A output. The input (V_{IN}) is rated for 8 V to 14 V. Rated input voltage and output current range for the evaluation module are given in [Table 1](#). This evaluation module is designed to demonstrate the small printed-circuit-board areas that may be achieved when designing with the TPS54A20 regulator. The switching frequency is externally set at a nominal 2 MHz for each side, 4 MHz effective. The high-side and low-side MOSFETs are incorporated inside the TPS54A20 package along with the gate drive circuitry. The low drain-to-source on-resistance of the MOSFET allows the TPS54A20 to achieve high efficiencies and helps keep the junction temperature low at high output currents. The compensation components are internal to the integrated circuit (IC), and an external divider allows for an adjustable output voltage. Additionally, the TPS54A20 provides adjustable slow start and undervoltage lockout inputs. The absolute maximum input voltage is 15 V while switching and 17 V for non-switching conditions.

Table 1. Input Voltage and Output Current Summary

EVM	INPUT VOLTAGE RANGE	OUTPUT CURRENT RANGE
TPS54A20EVM-770	$V_{IN} = 9.2 \text{ V to } 14 \text{ V}$	0 A to 10 A

1.2 Performance Specification Summary

A summary of the TPS54A20EVM-770 performance specifications is provided in [Table 2](#). Specifications are given for an input voltage of $V_{IN} = 12 \text{ V}$ and an output voltage of 1.2 V, unless otherwise specified. The TPS54A20EVM-770 is designed and tested for $V_{IN} = 9.2 \text{ V to } 14 \text{ V}$. The ambient temperature is 25°C for all measurements, unless otherwise noted.

Table 2. TPS54A20EVM-770 Performance Specification Summary

SPECIFICATION	TEST CONDITIONS	MIN	TYP	MAX	UNIT	
V_{IN} voltage range		9.2	12	14	V	
V_{IN} start voltage			9.39		V	
V_{IN} stop voltage			9.14		V	
Output voltage setpoint			1.2		V	
Output current range	$V_{IN} = 9.2 \text{ V to } 14 \text{ V}$	0		10	A	
Line regulation	$I_O = 5 \text{ A}, V_{IN} = 9.2 \text{ V to } 14 \text{ V}$		$\pm 0.04\%$			
Load regulation	$V_{IN} = 12 \text{ V}, I_O = 0 \text{ A to } 10 \text{ A}$		$\pm 0.03\%$			
Load transient response	$I_O = 0 \text{ A to } 9 \text{ A}$	Voltage change	-60		mV	
		Recovery time	60		μs	
	$I_O = 9 \text{ A to } 0 \text{ A}$	Voltage change		60		mV
		Recovery time		60		μs
Loop bandwidth	$V_{IN} = 12 \text{ V}, I_O = 5 \text{ A}$		280		kHz	
Phase margin	$V_{IN} = 12 \text{ V}, I_O = 5 \text{ A}$		45		degree	
Input ripple voltage	$I_O = 10 \text{ A}$		90		mVPP	
Output ripple voltage	$I_O = 10 \text{ A}$		20		mVPP	
Output rise time			512		μs	
Operating frequency			2		MHz	
Maximum efficiency	TPS54A20EVM-770, $V_{IN} = 9 \text{ V}, I_O = 5 \text{ A}$		84.7%			

1.3 Modifications

These evaluation modules are designed to provide access to the features of the TPS54A20. Some modifications can be made to this module.

1.3.1 Output Voltage Setpoint

The output voltage is set by the resistor divider network of R9 ($R_{(TOP)}$) and R7 ($R_{(BOT)}$). R7 is fixed at 1 k Ω . To change the output voltage of the EVM, it is necessary to change the value of resistor R9. Changing the value of R9 can change the output voltage above the 0.508 V reference voltage V_{REF} . The value of R9 for a specific output voltage can be calculated using [Equation 1](#).

$$R_{(TOP)} = \frac{R_{(BOT)} \times (V_{OUT} - V_{REF})}{V_{REF}} \quad (1)$$

1.3.2 On Time

The TON pin requires a resistor to set the nominal on-time and to support the input voltage feed forward circuit. The resistance value used also influences the internal ramp in the controller. Use [Equation 2](#) for selecting the TON resistor.

$$R_{(TON)} = 3 \text{ k} + 15 \text{ k} \times V_{OUT} \quad (2)$$

The R_{TON} resistor selected for this design example is 22.1 k Ω . During startup, the converter uses the nominal on-time programmed through TON. The phase lock loop (PLL) is only activated after startup is complete. When the PLL is engaged, the on-time is adjusted. If the nominal on-time programmed through the TON pin is not close to the on-time when the PLL is engaged, the SYNC range of the device may be reduced. The TON resistor can also be adjusted to tune the controller. Lowering the R_{TON} value will increase the internal ramp height. This will reduce the converter's sensitivity to noise and jitter but it will also reduce the transient response capabilities of the converter.

1.3.3 Adjustable UVLO

The undervoltage lockout (UVLO) can be adjusted externally using R2 ($R_{EN(TOP)}$) and R3 ($R_{EN(BOT)}$). The EVM is set for a start voltage of 9.385 V and a stop voltage of 9.144 V using R2 = 80.6 k Ω and R3 = 12.4 k Ω . Use [Equation 3](#) and [Equation 4](#) to calculate required resistor values for different start and stop voltages. $I_{EN(FALL)} = 4 \mu\text{A}$, $I_{EN(RISE)} = 1 \mu\text{A}$ and $V_{EN} = 1.23 \text{ V}$

$$R_{EN(TOP)} = \frac{V_{IN(RISE)} - V_{IN(FALL)}}{I_{EN(FALL)} - I_{EN(RISE)}} \quad (3)$$

$$R_{EN(BOT)} = \frac{R_{EN(TOP)} \times V_{EN}}{V_{IN(FALL)} - V_{EN} + R_{EN(TOP)} \times I_{EN(FALL)}} \quad (4)$$

2 Test Setup and Results

This section describes how to properly connect, set up, and use the TPS54A20EVM-770 evaluation module. The section also includes test results typical for the evaluation module and covers efficiency, output voltage regulation, load transients, loop response, output ripple, input ripple, and start-up.

2.1 Input/Output Connections

The TPS54A20EVM-770 is provided with input/output connectors and test points as shown in [Table 3](#). A power supply capable of supplying greater than 2 A must be connected to J1 through a pair of 20 AWG wires or better. The load must be connected to J4 through a pair of 20 AWG wires or better. The maximum load current capability is 10 A. Wire lengths must be minimized to reduce losses in the wires. Test-point TP1 provides a place to monitor the V_{IN} input voltages with TP2 providing a convenient ground reference. TP7 is used to monitor the output voltage with TP8 as the ground reference.

Table 3. EVM Connectors and Test Points

Reference Designator	Function
J1	VIN input voltage connector. (See Table 1 for V_{IN} range).
J2	2-pin header for enable. Connect EN to ground to disable, open to enable.
J3	External VG+ header. To improve converter efficiency, an external 5V supply is recommended to be connected to the VG+ pin (J3-2) to GND (J3-1).
J4	V_{OUT} , 1.2 V at 10 A maximum.
TP1	VIN test point.
TP2	GND test point at VIN connector.
TP3	PGOOD test point.
TP4	SYNC test point.
TP5	VG+ test point.
TP6	Test point between voltage divider network and output. Used for loop response measurements.
TP7	Output voltage test point.
TP8	GND test point
TP9	Test point at gate of transient load circuit.
TP10	GND test point at input of transient load circuit.
TP11	Test point at top of transient load circuit load resistor
TP12	Test point at bottom (GND) of transient load circuit load resistor
TP13	Analog ground (AGND) test point.

2.2 Efficiency

The efficiency of this EVM peaks at a load current of about 5 A and then decreases as the load current increases toward full load. Figure 1 shows the efficiency for the TPS54A20EVM-770 at an ambient temperature of 25°C.

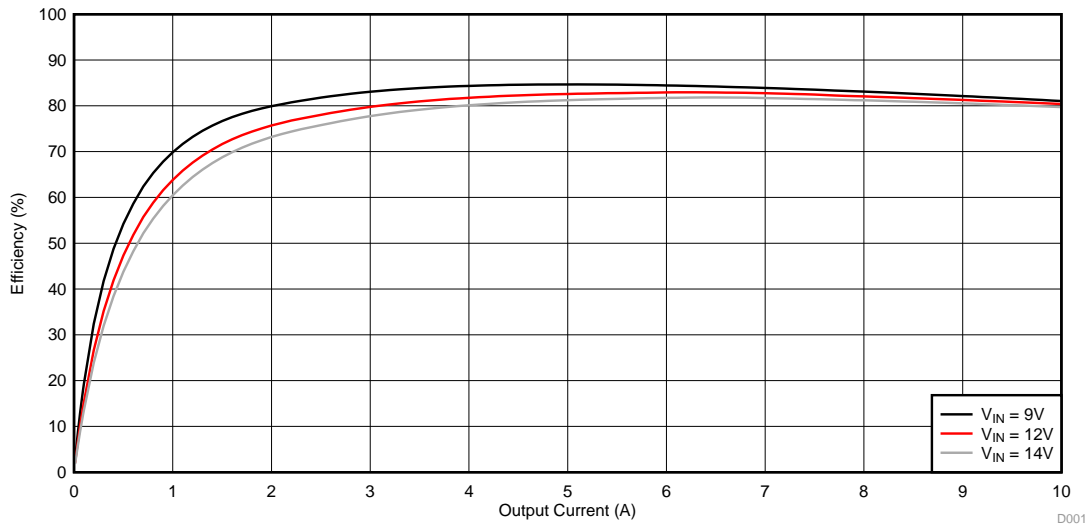

Figure 1. TPS54A20EVM-770 Efficiency

Figure 2 shows the efficiency for the TPS54A20EVM-770 using a semi-log scale to more easily show efficiency at lower output currents. The ambient temperature is 25°C.

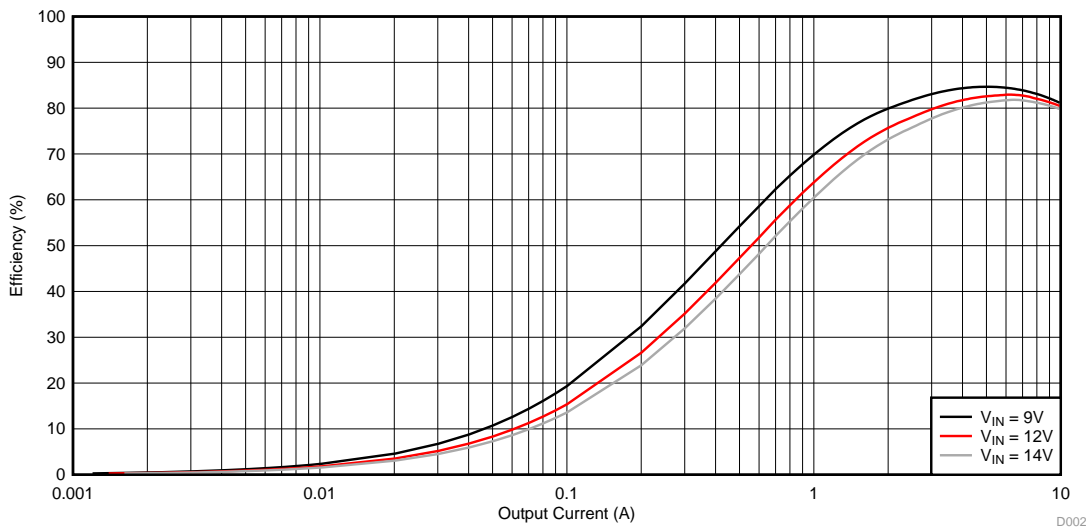

Figure 2. TPS54A20EVM-770 Low Current Efficiency

The efficiency may be lower at higher ambient temperatures, due to temperature variation in the drain-to-source resistance of the internal MOSFET.

2.3 Output Voltage Load Regulation

Figure 3 shows the load regulation for the TPS54A20EVM-770.

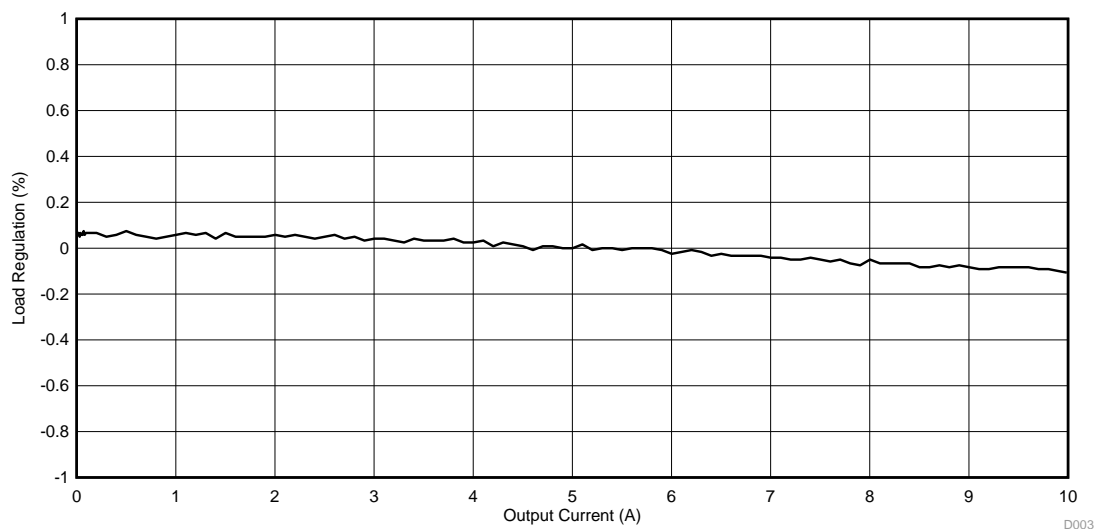

Figure 3. TPS54A20EVM-770 Load Regulation

Measurements are given for an ambient temperature of 25°C.

2.4 Output Voltage Line Regulation

Figure 4 shows the line regulation for the TPS54A20EVM-770.

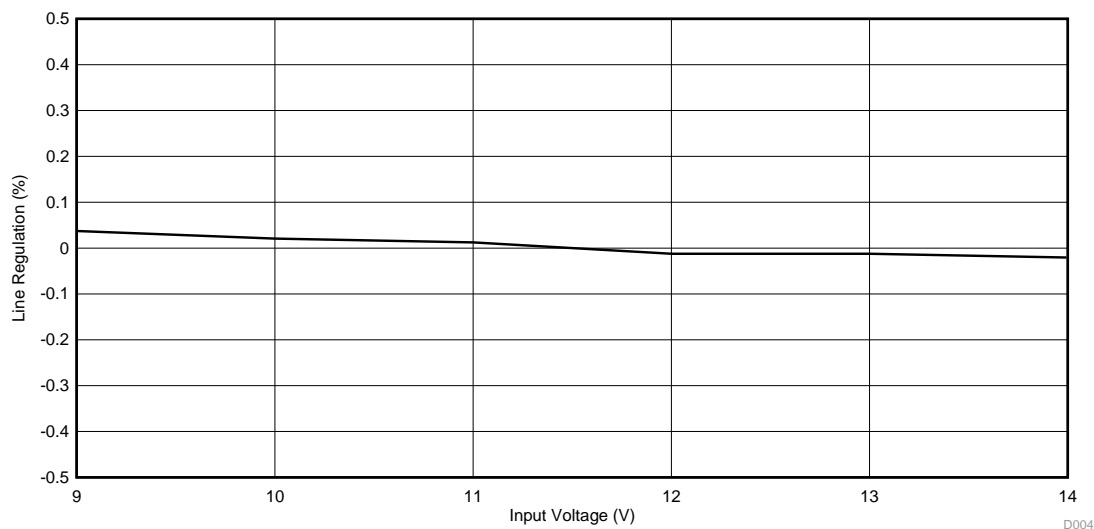

Figure 4. TPS54A20EVM-770 Line Regulation

2.5 Load Transients

Figure 5 shows the TPS54A20EVM-770 response to load transients. The current step is from 0 A to 9 A. The current step slew rate is 9 A/ μ s. Total peak-to-peak voltage variation is as shown, including ripple and noise on the output. The transient waveform is measured using the on-board fast transient circuit.

CAUTION
Q1 may get hot. Limit the power dissipation to 3W or less. Use low duty cycles.

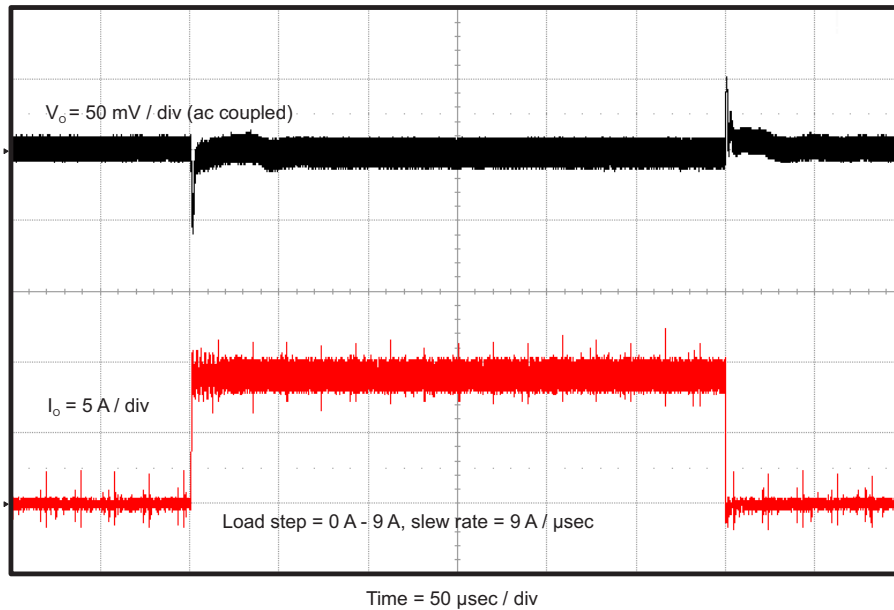

Figure 5. TPS54A20EVM-770 Transient Response

2.6 Loop Characteristics

Figure 6 shows the TPS54A20EVM-770 loop-response characteristics. Gain and phase plots are shown for V_{IN} voltage of 12 V. Load current for the measurement is 5 A.

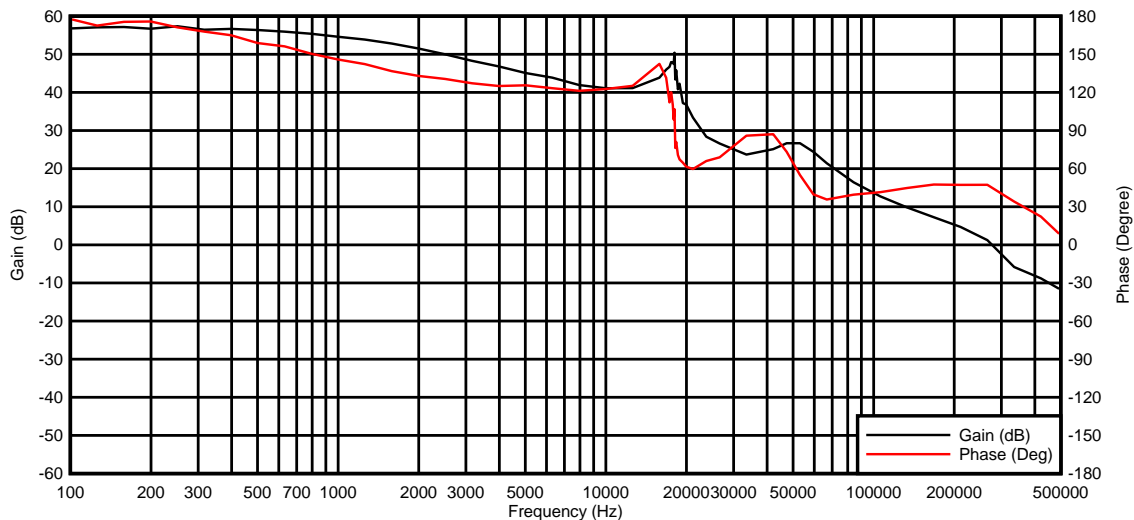

Figure 6. TPS54A20EVM-770 Loop Response

2.7 Output Voltage Ripple

Figure 7, Figure 8, and Figure 9 show the TPS54A20EVM-770 output voltage ripple. The load currents are 0 A, 5 A and 10 A. $V_{IN} = 12\text{ V}$. The ripple voltage is measured directly across TP7 and TP8.

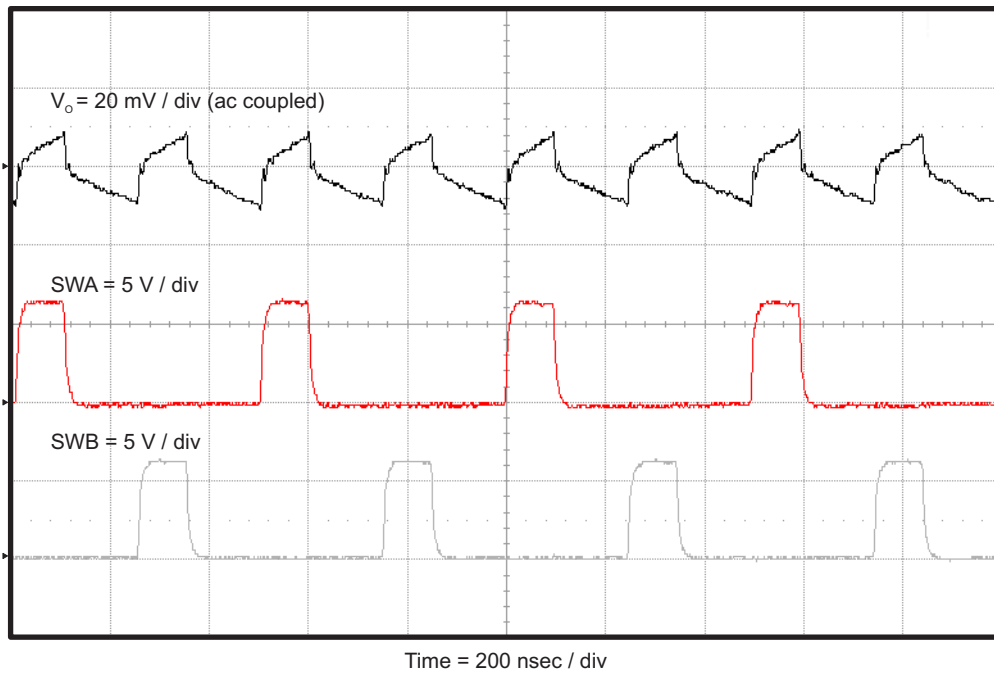

Figure 7. TPS54A20EVM-770 Output Ripple, 0 A Load

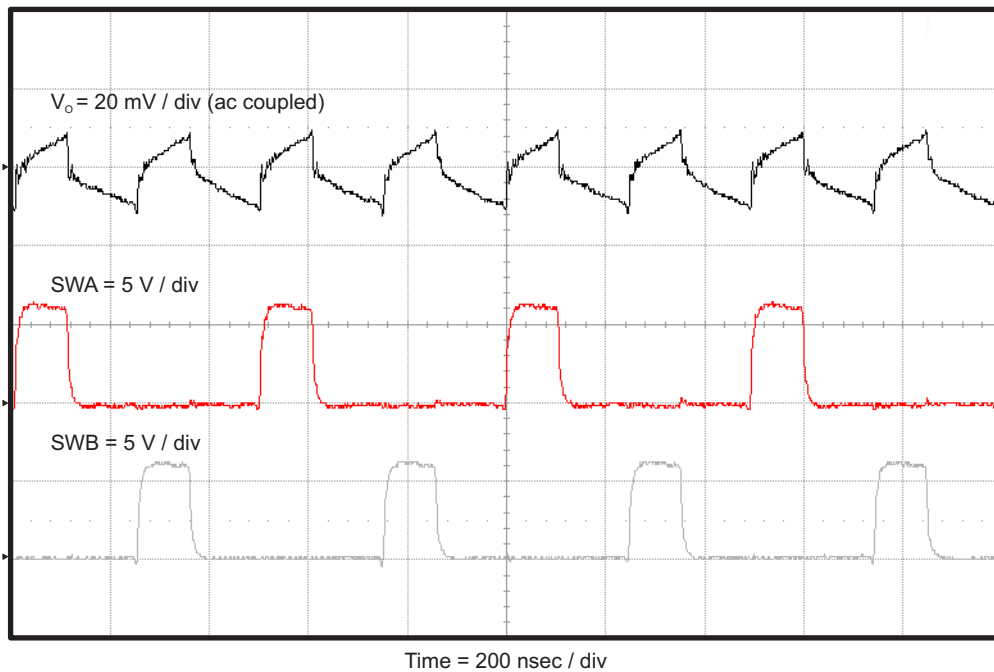

Figure 8. TPS54A20EVM-770 Output Ripple, 5 A Load

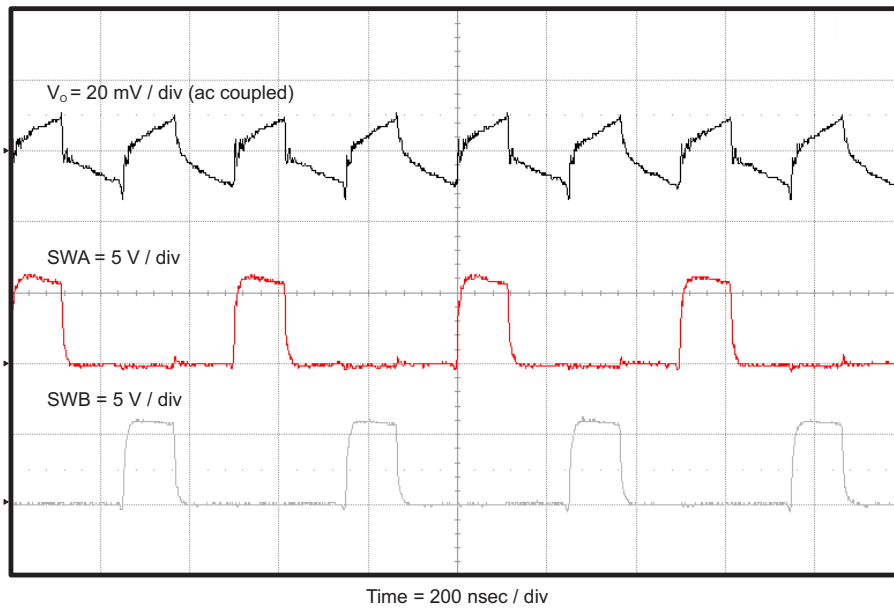

Figure 9. TPS54A20EVM-770 Output Ripple, 10 A Load

2.8 Input Voltage Ripple

Figure 10, Figure 11 and Figure 12 show the TPS54A20EVM-770 input voltage ripple. The load currents are 0 A, 5 A and 10 A. $V_{IN} = 12 \text{ V}$. The ripple voltage is measured directly across TP1 and TP2.

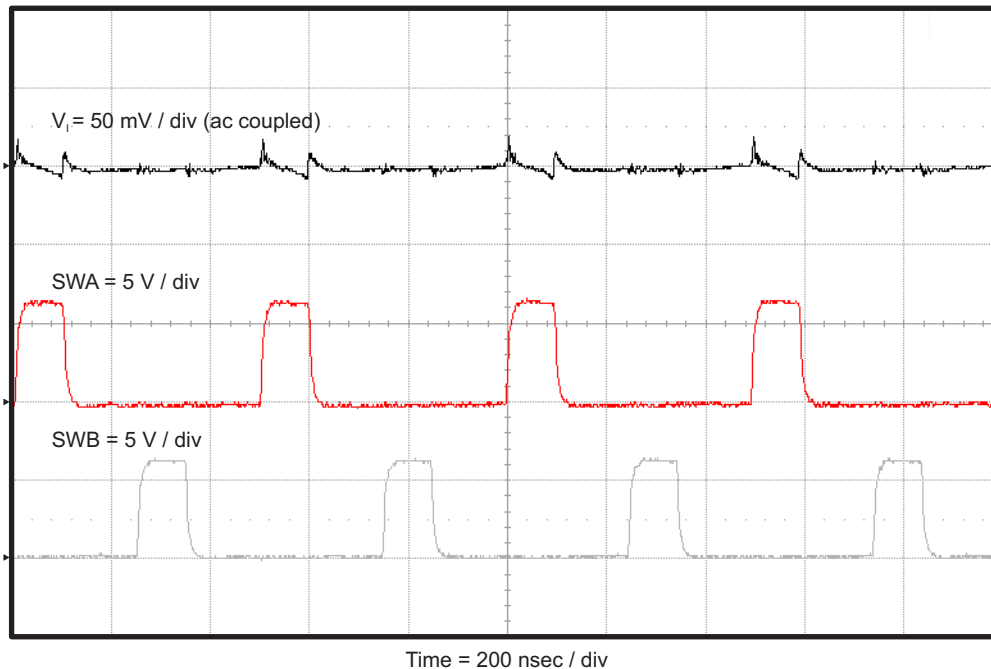

Figure 10. TPS54A20EVM-770 Input Ripple, 0 A Load

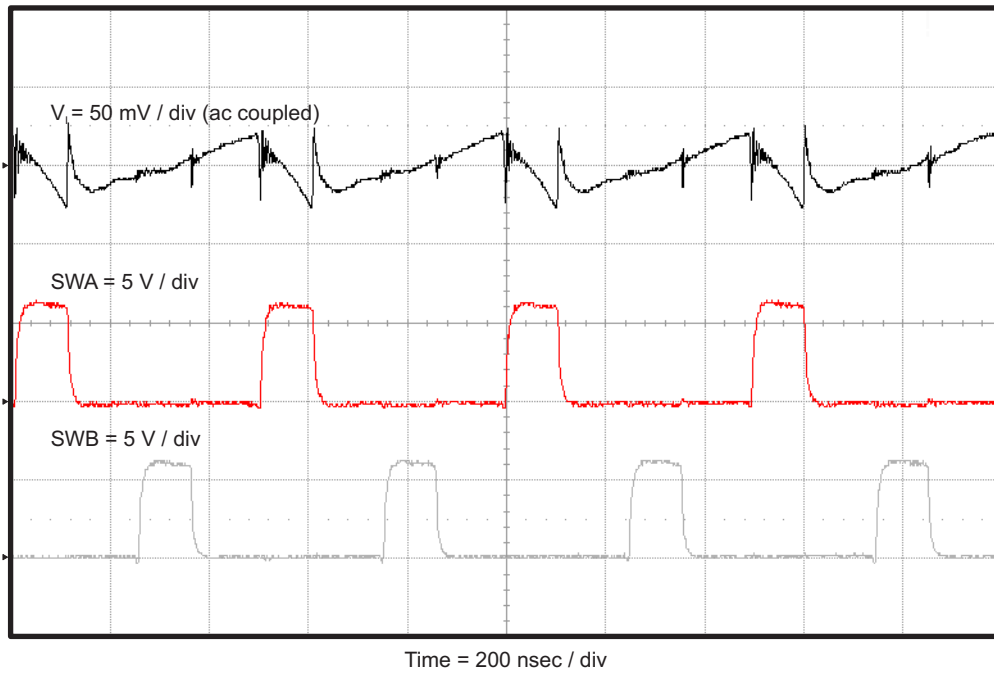

Figure 11. TPS54A20EVM-770 Input Ripple, 5 A Load

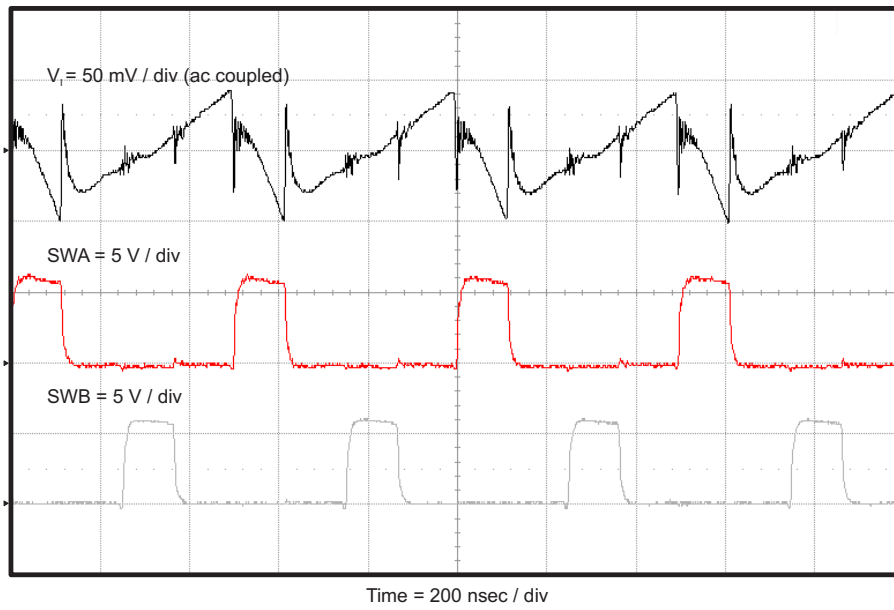

Figure 12. TPS54A20EVM-770 Input Ripple, 10 A Load

2.9 Powering Up

Figure 13 and Figure 14 show the start-up waveforms for the TPS54A20EVM-770. In Figure 13, the output voltage ramps up as soon as the input voltage reaches the UVLO threshold as set by the R2 and R3 resistor divider network. In Figure 14, the input voltage is initially applied and the output is inhibited by using a jumper at J2 to tie EN to GND. When the jumper is removed, EN is released. When the EN voltage reaches the enable-threshold voltage, the start-up sequence begins and the output voltage ramps up to the externally set value of 1.2 V. The input voltage for these plots is 12 V and the load is 1 Ω .

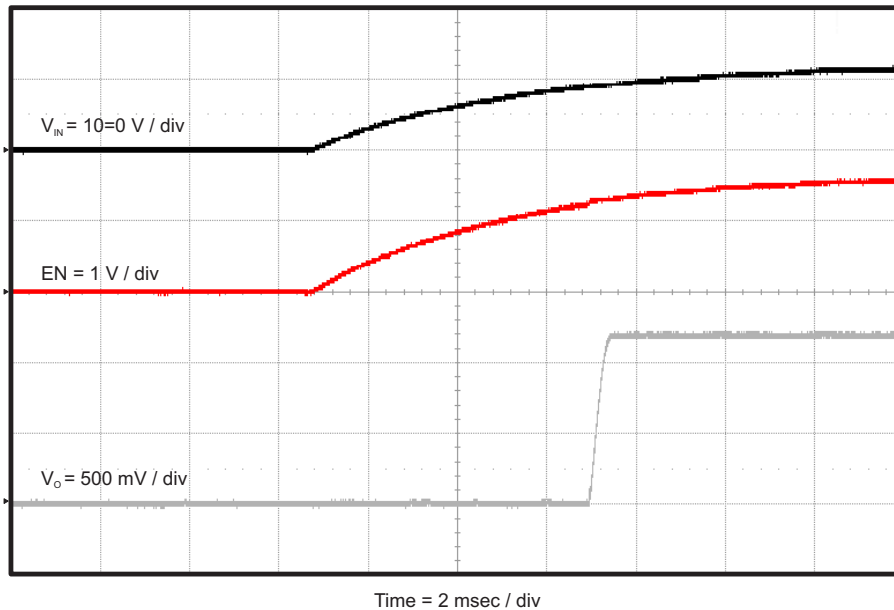

Figure 13. TPS54A20EVM-770 Start-Up Relative to V_{IN}

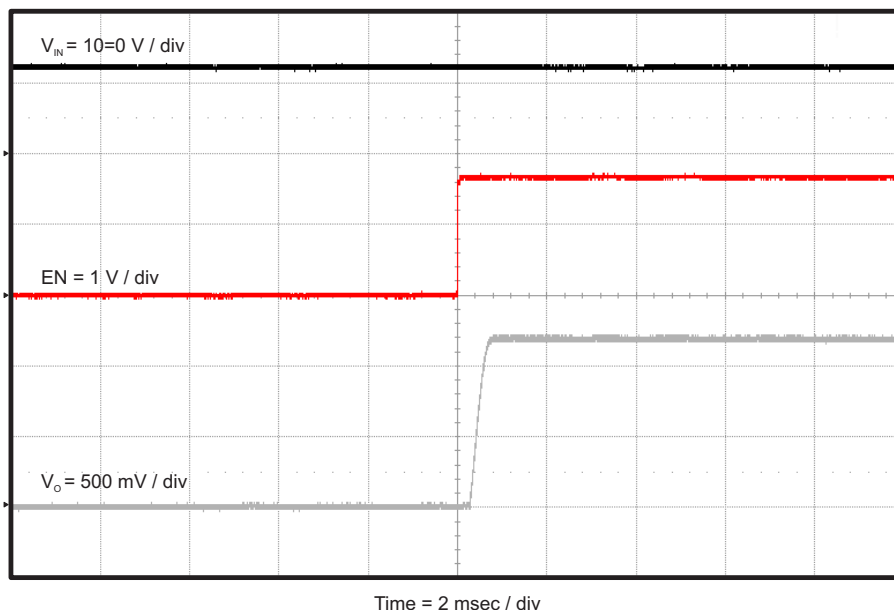
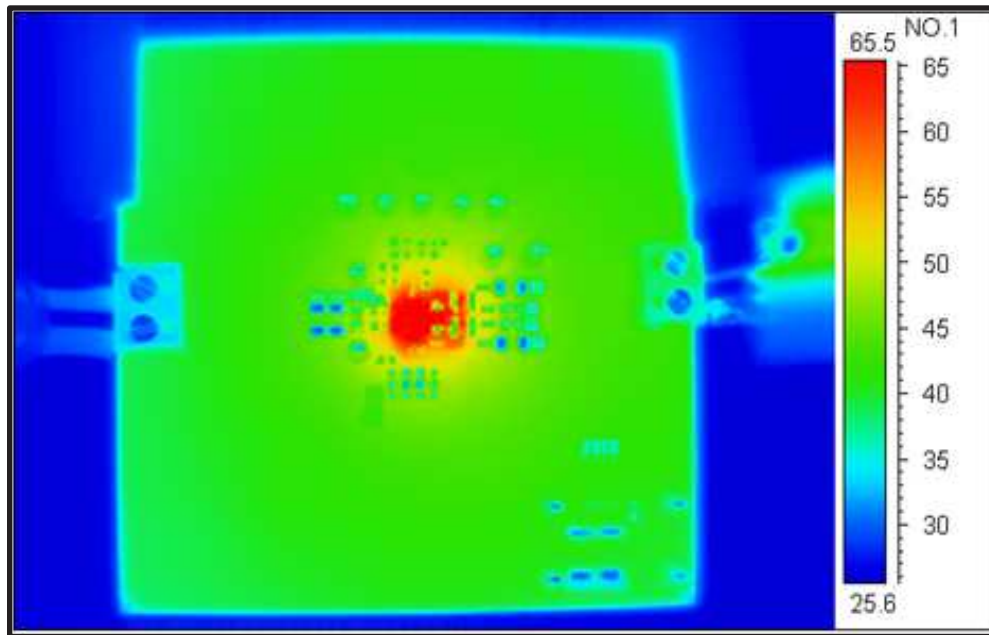

Figure 14. TPS54A20EVM-770 Start-Up Relative to Enable

2.10 Thermal Image

The EVM thermal image is shown in [Figure 15](#). The input voltage is 12 V and the output current is 10A. The EVM was allowed to operate at full 10 A load for > 45 minutes before the image was captured.



Maximum Case Temperature = 76.3 °C

Figure 15. Thermal Image

3 Board Layout

This section provides a description of the TPS54A20EVM-770 board layout and layer illustrations.

3.1 Layout

The board layout for the TPS54A20EVM-770 is shown in [Figure 16](#) through [Figure 20](#). The top-side layer of the EVM is laid out in a manner typical of a user application. The top, bottom, and internal layers are 2-oz. copper.

The top layer contains the main power traces for VIN, V_{OUT} , SWA and SWB. Also on the top layer are connections for the remaining pins of the TPS54A20 and a large area filled with ground. The internal layer-1 is dedicated ground plane. The internal layer-2 contain an additional large ground copper area as well as an additional V_{OUT} copper fill. The bottom layer is another ground plane with an additional trace for the output voltage feedback. The top-side ground traces are connected to the bottom and internal ground planes with multiple vias placed around the board including five vias directly under the TPS54A20 device to provide a thermal path from the top-side ground plane to the bottom-side ground plane.

The input decoupling capacitors and bootstrap capacitor are all located as close to the IC as possible. Additionally, the voltage setpoint resistor divider components are kept close to the IC. The voltage divider network ties to the output voltage at the point of regulation, the copper V_{OUT} trace at the TP7 test point. For the TPS54A20, an additional input bulk capacitor may be required, depending on the EVM connection to the input supply. Critical analog circuits such as the voltage set point divider, frequency set resistor, and compensation components are terminated to ground using a wide ground trace separate from the power ground pour.

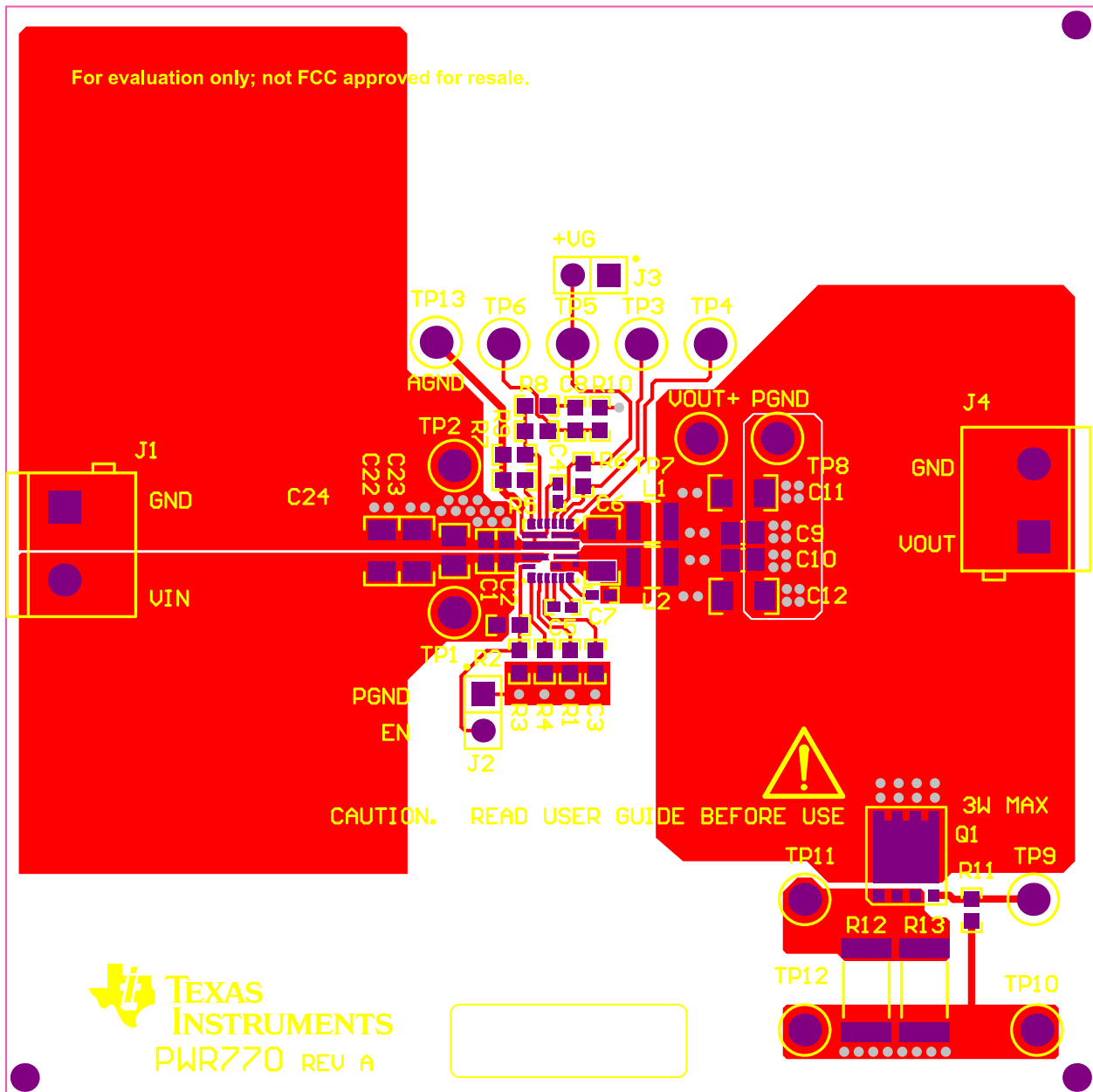

Figure 16. TPS54A20EVM-770 Top-Side Assembly

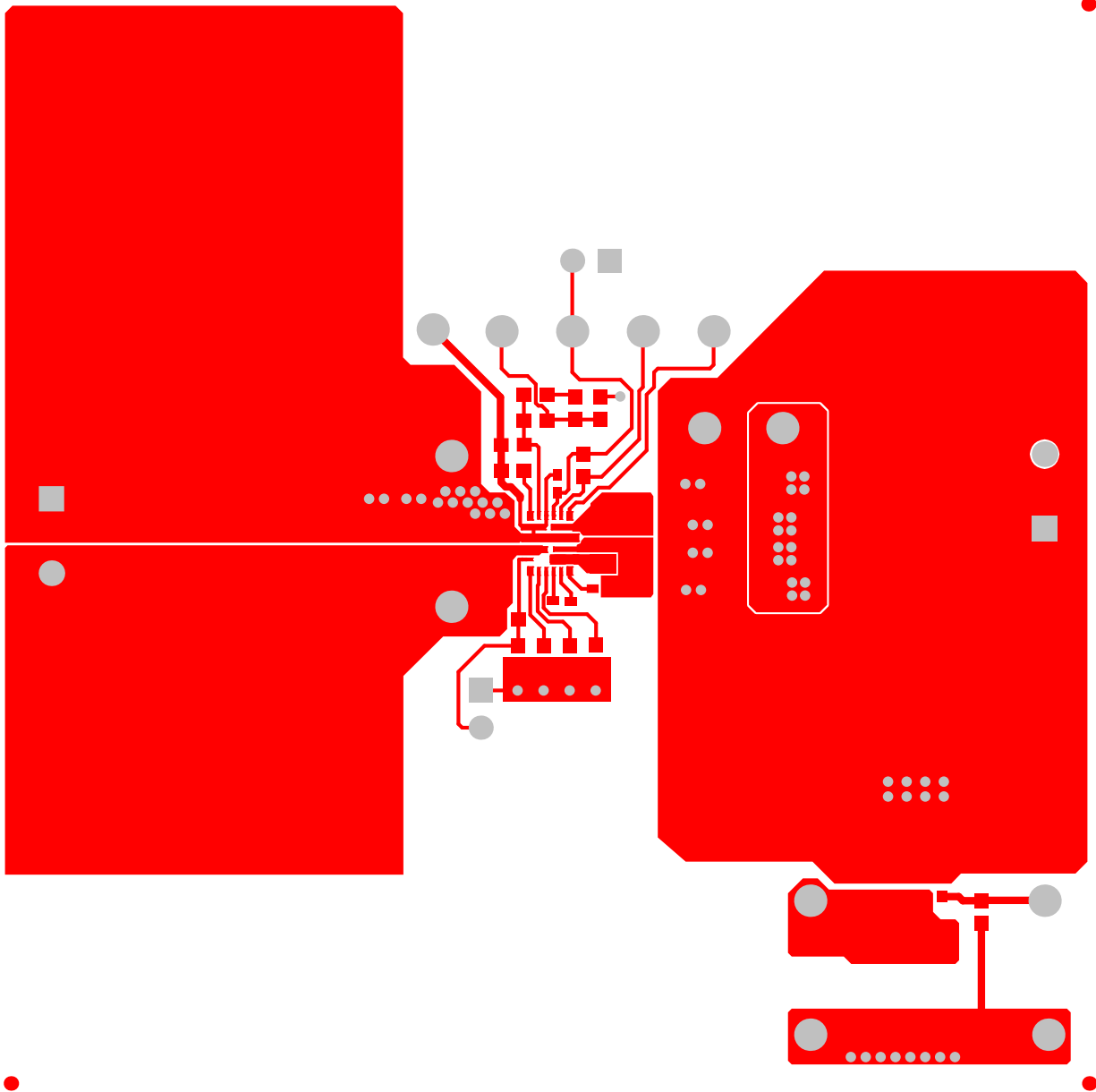

Figure 17. TPS54A20EVM-770 Top-Side Layout

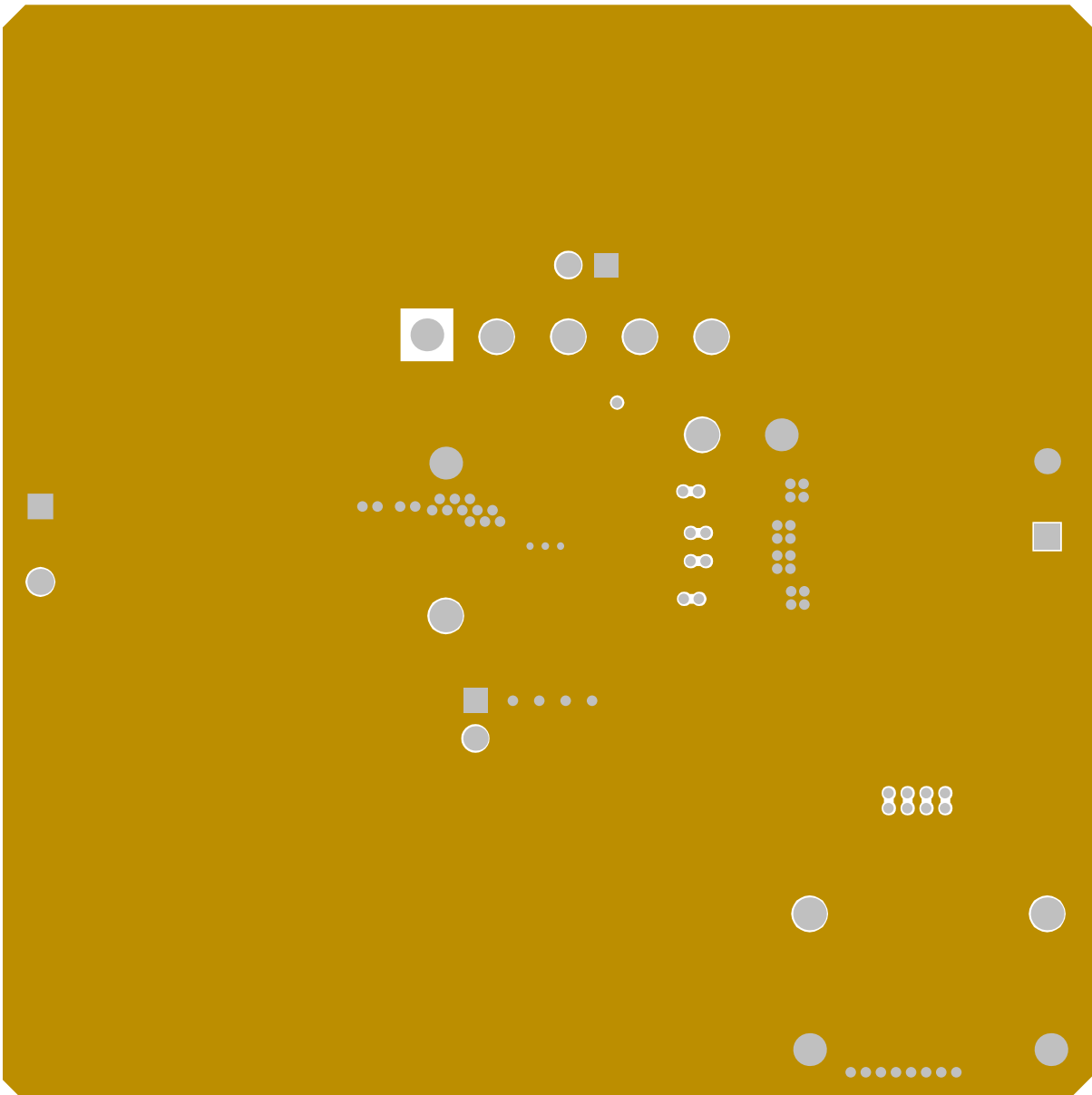

Figure 18. TPS54A20EVM-770 Internal Layer-1 Layout

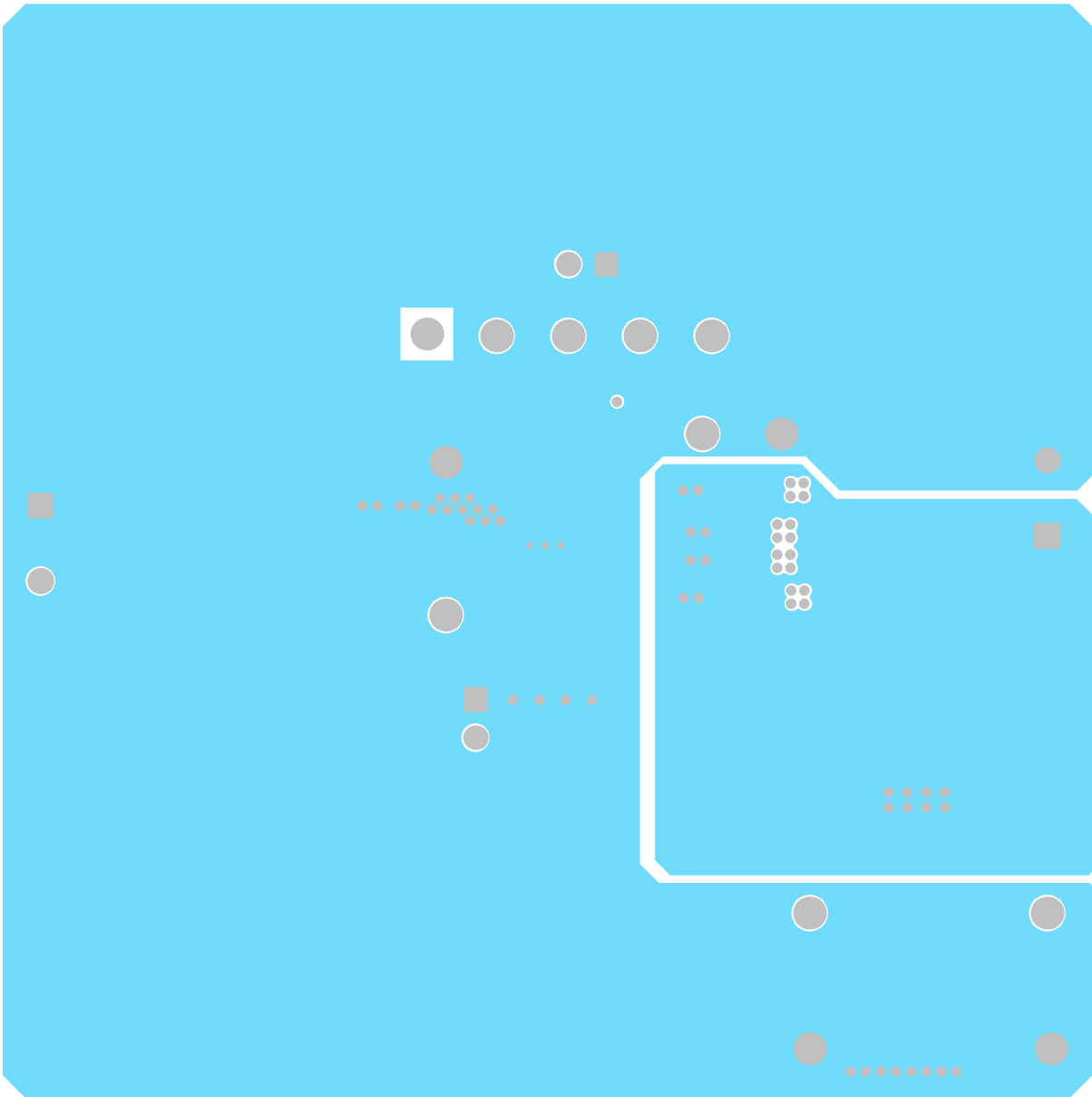

Figure 19. TPS54A20EVM-770 Internal Layer-2 Layout

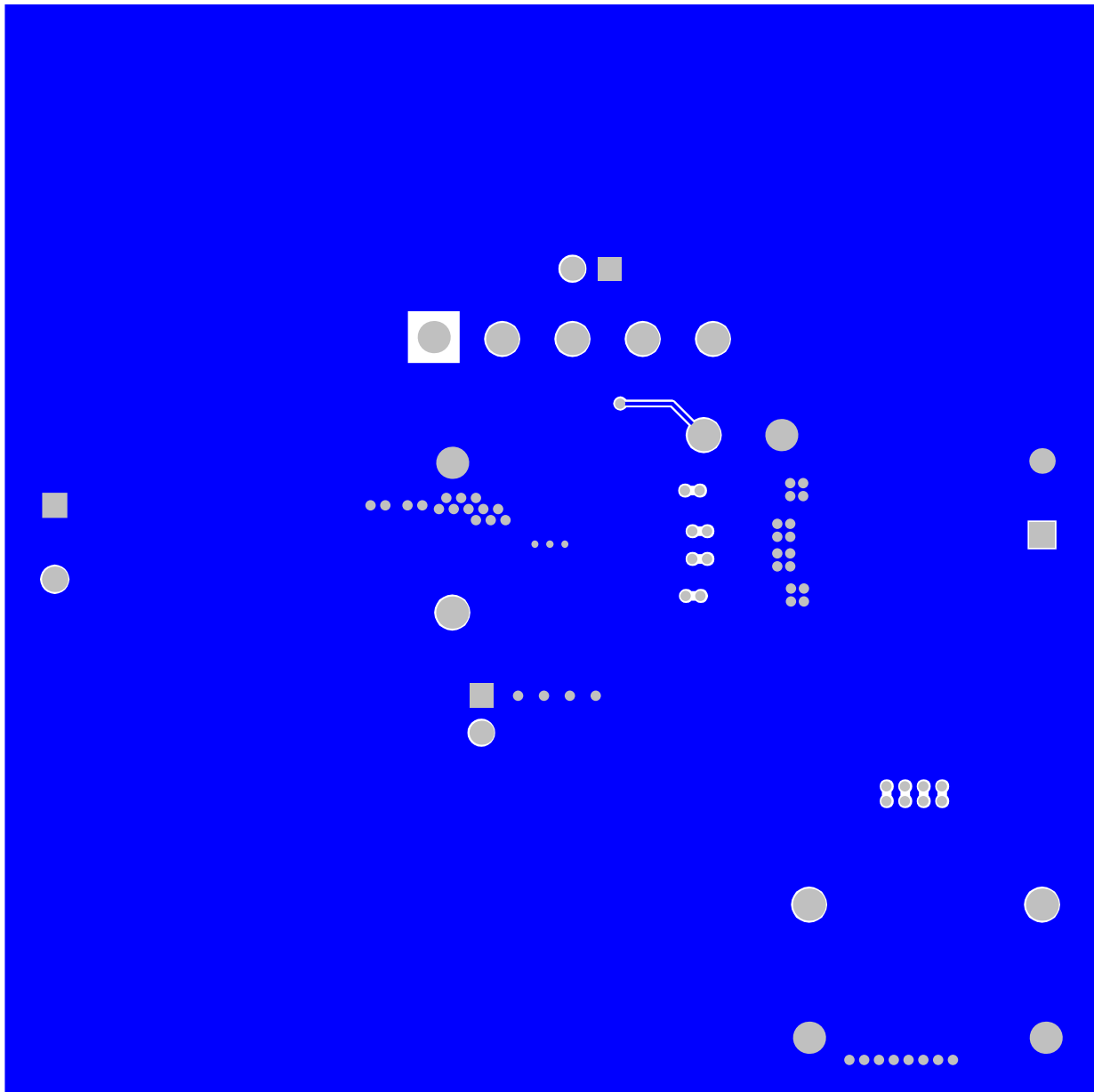

Figure 20. TPS54A20EVM-770 Bottom-Side Layout

4 Schematic and Bill of Materials

This section presents the TPS54A20EVM-770 schematic and bill of materials.

4.1 Schematic

Figure 21 is the schematic for the TPS54A20EVM-770.

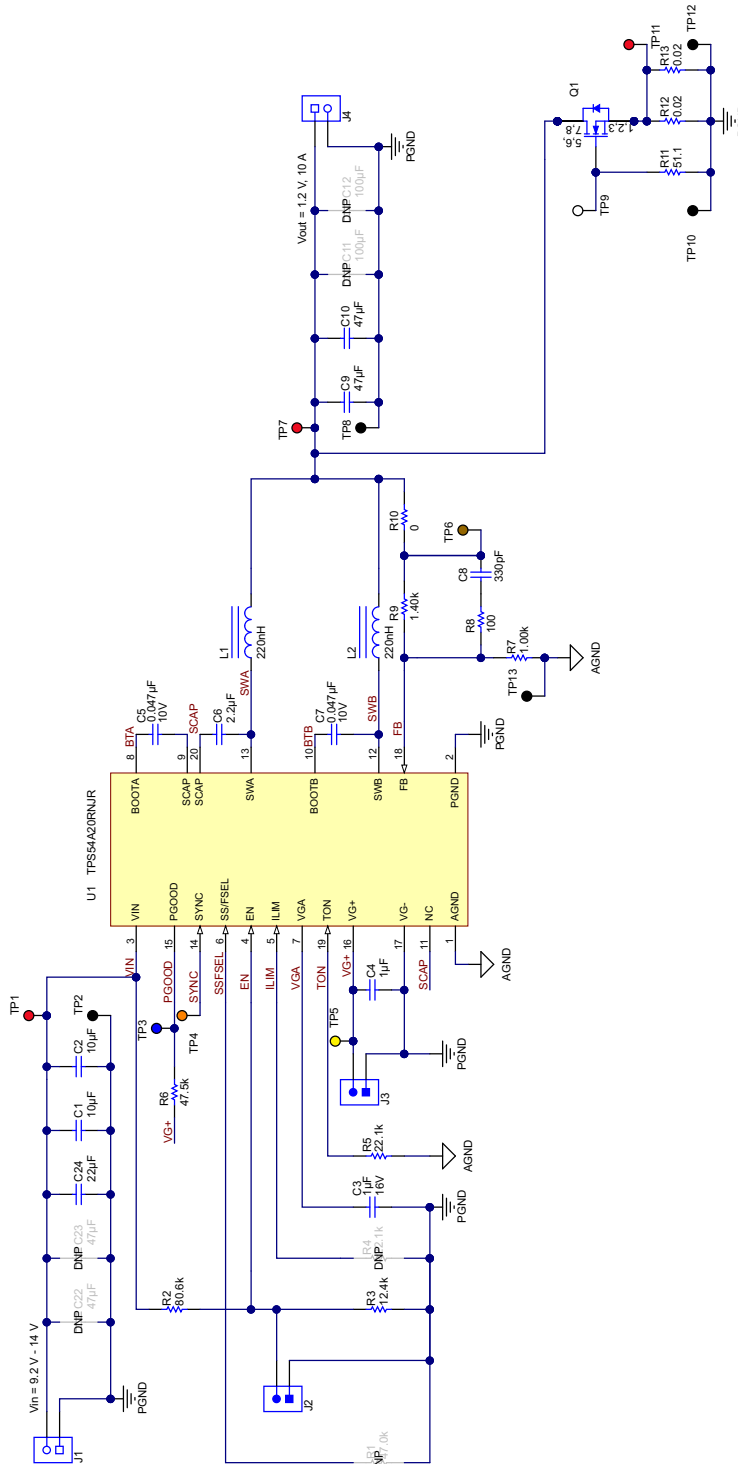

Figure 21. TPS54A20EVM-770 Schematic

4.2 Bill of Materials

Table 4 presents the bill of materials for the TPS54A20EVM-770.

Table 4. TPS54A20EVM-770 Bill of Materials

Designator	Quantity	Value	Description	Package Reference	Part Number	Manufacturer
PCB	1		Printed Circuit Board		PWR770	Any
C1, C2	2	10uF	CAP, CERM, 10 µF, 25 V, +/- 20%, X5R, 0603		C1608X5R1E106M080AC	TDK
C3	1	1uF	CAP, CERM, 1 µF, 16 V, +/- 10%, X7R, 0603		C1608X7R1C105K	TDK
C4	1	1uF	CAP, CERM, 1 µF, 10 V, +/- 10%, X5R, 0402	0402	C1005X5R1A105K050BB	TDK
C5, C7	2	0.047uF	CAP, CERM, 0.047 µF, 10 V, +/- 10%, X5R, 0402		C1005X5R1A473K050BA	TDK
C6	1	2.2uF	CAP, CERM, 2.2 µF, 16 V, +/- 10%, X7R, 1206	1206	GRM31MR71C225KA35L	MuRata
C8	1	330pF	CAP, CERM, 330 pF, 50 V, +/- 5%, C0G/NP0, 0603	0603	C1608C0G1H331J	TDK
C9, C10	2	47uF	CAP, CERM, 47 µF, 10 V, +/- 20%, X5R, 0805	0805	GRM21BR61A476ME15	MuRata
C24	1	22uF	CAP, CERM, 22 µF, 35 V, +/- 20%, X5R, 0805		C2012X5R1V226M125AC	TDK
J1, J4	2		TERMINAL BLOCK 5.08MM VERT 2POS, TH		ED120/2DS	On-Shore Technology
J2	1		Header, 100mil, 2x1, Gold, TH	Header, 100mil, 2x1, TH	HTSW-102-07-G-S	Samtec
J3	1		Header, 100mil, 2x1, Gold, TH		HTSW-102-07-G-S	Samtec
L1, L2	2	220nH	Inductor, 220 nH, 7.2 A, 0.0075 ohm, SMD	3.2x2.5mm	MLA-FY12NR22N-M3-RU	Mag Layers
LBL1	1		Thermal Transfer Printable Labels, 0.650" W x 0.200" H - 10,000 per roll	PCB Label 0.650"H x 0.200"W	THT-14-423-10	Brady
Q1	1	30V	MOSFET, N-CH, 30 V, 65 A, SON 5x6mm		CSD17527Q5A	Texas Instruments
R2	1	80.6k	RES, 80.6 k, 1%, 0.1 W, 0603	0603	CRCW060380K6FKEA	Vishay-Dale
R3	1	12.4k	RES, 12.4 k, 1%, 0.1 W, 0603	0603	CRCW060312K4FKEA	Vishay-Dale
R5	1	22.1k	RES, 22.1 k, 1%, 0.1 W, 0603		RC0603FR-0722K1L	Yageo America
R6	1	47.5k	RES, 47.5 k, 1%, 0.1 W, 0603	0603	RC0603FR-0747K5L	Yageo America
R7	1	1.00k	RES, 1.00 k, 1%, 0.1 W, 0603	0603	CRCW06031K00FKEA	Vishay-Dale
R8	1	100	RES, 100, 1%, 0.1 W, 0603	0603	CRCW0603100RFKEA	Vishay-Dale
R9	1	1.40k	RES, 1.40 k, 1%, 0.1 W, 0603	0603	CRCW06031K40FKEA	Vishay-Dale
R10	1	0	RES, 0, 5%, 0.1 W, 0603	0603	ERJ-3GEY0R00V	Panasonic
R11	1	51.1	RES, 51.1, 0.1%, 0.1 W, 0603		RT0603BRD0751R1L	Yageo America
R12, R13	2	0.02	RES, 0.02, 1%, 3 W, 2512		CRA2512-FZ-R020ELF	Bourns
SH-J1	1	1x2	Shunt, 100mil, Gold plated, Black	Shunt	SNT-100-BK-G	Samtec
TP1, TP7, TP11	3	Red	Test Point, Multipurpose, Red, TH	Red Multipurpose Testpoint	5010	Keystone
TP2, TP8, TP10, TP12, TP13	5	Black	Test Point, Multipurpose, Black, TH		5011	Keystone
TP3	1	Blue	Test Point, Multipurpose, Blue, TH	Blue Multipurpose Testpoint	5127	Keystone
TP4	1	Orange	Test Point, Multipurpose, Orange, TH		5013	Keystone
TP5	1	Yellow	Test Point, Multipurpose, Yellow, TH		5014	Keystone
TP6	1	Brown	Test Point, Multipurpose, Brown, TH		5125	Keystone
TP9	1	White	Test Point, Multipurpose, White, TH	White Multipurpose Testpoint	5012	Keystone
U1	1		10A/14V Series Capacitor Buck Converter, RNJ0020A	RNJ0020A	TPS54A20RNJR	Texas Instruments
C11, C12	0	100uF	CAP, CERM, 100 µF, 6.3 V, +/- 20%, X5R, 1206		JMK316BJ107ML-T	Taiyo Yuden

Table 4. TPS54A20EVM-770 Bill of Materials (continued)

Designator	Quantity	Value	Description	Package Reference	Part Number	Manufacturer
C22, C23	0	47uF	CAP, CERM, 47 μ F, 25 V, +/- 20%, X5R, 1206		C3216X5R1E476M160AC	TDK
FID1, FID2, FID3	0		Fiducial mark. There is nothing to buy or mount.	Fiducial	N/A	N/A
R1	0	47.0k	RES, 47.0 k, 1%, 0.1 W, 0603		RC0603FR-0747KL	Yageo America
R4	0	22.1k	RES, 22.1 k, 1%, 0.1 W, 0603		RC0603FR-0722K1L	Yageo America

STANDARD TERMS AND CONDITIONS FOR EVALUATION MODULES

1. *Delivery:* TI delivers TI evaluation boards, kits, or modules, including any accompanying demonstration software, components, or documentation (collectively, an "EVM" or "EVMs") to the User ("User") in accordance with the terms and conditions set forth herein. Acceptance of the EVM is expressly subject to the following terms and conditions.
 - 1.1 EVMs are intended solely for product or software developers for use in a research and development setting to facilitate feasibility evaluation, experimentation, or scientific analysis of TI semiconductor products. EVMs have no direct function and are not finished products. EVMs shall not be directly or indirectly assembled as a part or subassembly in any finished product. For clarification, any software or software tools provided with the EVM ("Software") shall not be subject to the terms and conditions set forth herein but rather shall be subject to the applicable terms and conditions that accompany such Software
 - 1.2 EVMs are not intended for consumer or household use. EVMs may not be sold, sublicensed, leased, rented, loaned, assigned, or otherwise distributed for commercial purposes by Users, in whole or in part, or used in any finished product or production system.
2. *Limited Warranty and Related Remedies/Disclaimers:*
 - 2.1 These terms and conditions do not apply to Software. The warranty, if any, for Software is covered in the applicable Software License Agreement.
 - 2.2 TI warrants that the TI EVM will conform to TI's published specifications for ninety (90) days after the date TI delivers such EVM to User. Notwithstanding the foregoing, TI shall not be liable for any defects that are caused by neglect, misuse or mistreatment by an entity other than TI, including improper installation or testing, or for any EVMs that have been altered or modified in any way by an entity other than TI. Moreover, TI shall not be liable for any defects that result from User's design, specifications or instructions for such EVMs. Testing and other quality control techniques are used to the extent TI deems necessary or as mandated by government requirements. TI does not test all parameters of each EVM.
 - 2.3 If any EVM fails to conform to the warranty set forth above, TI's sole liability shall be at its option to repair or replace such EVM, or credit User's account for such EVM. TI's liability under this warranty shall be limited to EVMs that are returned during the warranty period to the address designated by TI and that are determined by TI not to conform to such warranty. If TI elects to repair or replace such EVM, TI shall have a reasonable time to repair such EVM or provide replacements. Repaired EVMs shall be warranted for the remainder of the original warranty period. Replaced EVMs shall be warranted for a new full ninety (90) day warranty period.
3. *Regulatory Notices:*
 - 3.1 *United States*
 - 3.1.1 *Notice applicable to EVMs not FCC-Approved:*

This kit is designed to allow product developers to evaluate electronic components, circuitry, or software associated with the kit to determine whether to incorporate such items in a finished product and software developers to write software applications for use with the end product. This kit is not a finished product and when assembled may not be resold or otherwise marketed unless all required FCC equipment authorizations are first obtained. Operation is subject to the condition that this product not cause harmful interference to licensed radio stations and that this product accept harmful interference. Unless the assembled kit is designed to operate under part 15, part 18 or part 95 of this chapter, the operator of the kit must operate under the authority of an FCC license holder or must secure an experimental authorization under part 5 of this chapter.
 - 3.1.2 *For EVMs annotated as FCC – FEDERAL COMMUNICATIONS COMMISSION Part 15 Compliant:*

CAUTION

This device complies with part 15 of the FCC Rules. Operation is subject to the following two conditions: (1) This device may not cause harmful interference, and (2) this device must accept any interference received, including interference that may cause undesired operation.

Changes or modifications not expressly approved by the party responsible for compliance could void the user's authority to operate the equipment.

FCC Interference Statement for Class A EVM devices

NOTE: This equipment has been tested and found to comply with the limits for a Class A digital device, pursuant to part 15 of the FCC Rules. These limits are designed to provide reasonable protection against harmful interference when the equipment is operated in a commercial environment. This equipment generates, uses, and can radiate radio frequency energy and, if not installed and used in accordance with the instruction manual, may cause harmful interference to radio communications. Operation of this equipment in a residential area is likely to cause harmful interference in which case the user will be required to correct the interference at his own expense.

FCC Interference Statement for Class B EVM devices

NOTE: This equipment has been tested and found to comply with the limits for a Class B digital device, pursuant to part 15 of the FCC Rules. These limits are designed to provide reasonable protection against harmful interference in a residential installation. This equipment generates, uses and can radiate radio frequency energy and, if not installed and used in accordance with the instructions, may cause harmful interference to radio communications. However, there is no guarantee that interference will not occur in a particular installation. If this equipment does cause harmful interference to radio or television reception, which can be determined by turning the equipment off and on, the user is encouraged to try to correct the interference by one or more of the following measures:

- Reorient or relocate the receiving antenna.
- Increase the separation between the equipment and receiver.
- Connect the equipment into an outlet on a circuit different from that to which the receiver is connected.
- Consult the dealer or an experienced radio/TV technician for help.

3.2 Canada

3.2.1 For EVMs issued with an Industry Canada Certificate of Conformance to RSS-210

Concerning EVMs Including Radio Transmitters:

This device complies with Industry Canada license-exempt RSS standard(s). Operation is subject to the following two conditions: (1) this device may not cause interference, and (2) this device must accept any interference, including interference that may cause undesired operation of the device.

Concernant les EVMs avec appareils radio:

Le présent appareil est conforme aux CNR d'Industrie Canada applicables aux appareils radio exempts de licence. L'exploitation est autorisée aux deux conditions suivantes: (1) l'appareil ne doit pas produire de brouillage, et (2) l'utilisateur de l'appareil doit accepter tout brouillage radioélectrique subi, même si le brouillage est susceptible d'en compromettre le fonctionnement.

Concerning EVMs Including Detachable Antennas:

Under Industry Canada regulations, this radio transmitter may only operate using an antenna of a type and maximum (or lesser) gain approved for the transmitter by Industry Canada. To reduce potential radio interference to other users, the antenna type and its gain should be so chosen that the equivalent isotropically radiated power (e.i.r.p.) is not more than that necessary for successful communication. This radio transmitter has been approved by Industry Canada to operate with the antenna types listed in the user guide with the maximum permissible gain and required antenna impedance for each antenna type indicated. Antenna types not included in this list, having a gain greater than the maximum gain indicated for that type, are strictly prohibited for use with this device.

Concernant les EVMs avec antennes détachables

Conformément à la réglementation d'Industrie Canada, le présent émetteur radio peut fonctionner avec une antenne d'un type et d'un gain maximal (ou inférieur) approuvé pour l'émetteur par Industrie Canada. Dans le but de réduire les risques de brouillage radioélectrique à l'intention des autres utilisateurs, il faut choisir le type d'antenne et son gain de sorte que la puissance isotrope rayonnée équivalente (p.i.r.e.) ne dépasse pas l'intensité nécessaire à l'établissement d'une communication satisfaisante. Le présent émetteur radio a été approuvé par Industrie Canada pour fonctionner avec les types d'antenne énumérés dans le manuel d'usage et ayant un gain admissible maximal et l'impédance requise pour chaque type d'antenne. Les types d'antenne non inclus dans cette liste, ou dont le gain est supérieur au gain maximal indiqué, sont strictement interdits pour l'exploitation de l'émetteur.

3.3 Japan

3.3.1 *Notice for EVMs delivered in Japan:* Please see http://www.tij.co.jp/lstds/ti_ja/general/eStore/notice_01.page 日本国内に輸入される評価用キット、ボードについては、次のところをご覧ください。
http://www.tij.co.jp/lstds/ti_ja/general/eStore/notice_01.page

3.3.2 *Notice for Users of EVMs Considered "Radio Frequency Products" in Japan:* EVMs entering Japan may not be certified by TI as conforming to Technical Regulations of Radio Law of Japan.

If User uses EVMs in Japan, not certified to Technical Regulations of Radio Law of Japan, User is required by Radio Law of Japan to follow the instructions below with respect to EVMs:

1. Use EVMs in a shielded room or any other test facility as defined in the notification #173 issued by Ministry of Internal Affairs and Communications on March 28, 2006, based on Sub-section 1.1 of Article 6 of the Ministry's Rule for Enforcement of Radio Law of Japan,
2. Use EVMs only after User obtains the license of Test Radio Station as provided in Radio Law of Japan with respect to EVMs, or
3. Use of EVMs only after User obtains the Technical Regulations Conformity Certification as provided in Radio Law of Japan with respect to EVMs. Also, do not transfer EVMs, unless User gives the same notice above to the transferee. Please note that if User does not follow the instructions above, User will be subject to penalties of Radio Law of Japan.

【無線電波を送信する製品の開発キットをお使いになる際の注意事項】 開発キットの中には技術基準適合証明を受けていないものがあります。技術適合証明を受けていないもののご使用に際しては、電波法遵守のため、以下のいずれかの措置を取っていただく必要がありますのでご注意ください。

1. 電波法施行規則第6条第1項第1号に基づく平成18年3月28日総務省告示第173号で定められた電波暗室等の試験設備でご使用いただく。
2. 実験局の免許を取得後ご使用いただく。
3. 技術基準適合証明を取得後ご使用いただく。

なお、本製品は、上記の「ご使用にあたっての注意」を譲渡先、移転先に通知しない限り、譲渡、移転できないものとします。

上記を遵守頂けない場合は、電波法の罰則が適用される可能性があることをご留意ください。日本テキサス・インスツルメンツ株式会社
東京都新宿区西新宿 6 丁目 2 4 番 1 号
西新宿三井ビル

3.3.3 *Notice for EVMs for Power Line Communication:* Please see http://www.tij.co.jp/llds/ti_ja/general/eStore/notice_02.page
電力線搬送波通信についての開発キットをお使いになる際の注意事項については、次のところをご覧ください。http://www.tij.co.jp/llds/ti_ja/general/eStore/notice_02.page

4 *EVM Use Restrictions and Warnings:*

4.1 EVMS ARE NOT FOR USE IN FUNCTIONAL SAFETY AND/OR SAFETY CRITICAL EVALUATIONS, INCLUDING BUT NOT LIMITED TO EVALUATIONS OF LIFE SUPPORT APPLICATIONS.

4.2 User must read and apply the user guide and other available documentation provided by TI regarding the EVM prior to handling or using the EVM, including without limitation any warning or restriction notices. The notices contain important safety information related to, for example, temperatures and voltages.

4.3 *Safety-Related Warnings and Restrictions:*

4.3.1 User shall operate the EVM within TI's recommended specifications and environmental considerations stated in the user guide, other available documentation provided by TI, and any other applicable requirements and employ reasonable and customary safeguards. Exceeding the specified performance ratings and specifications (including but not limited to input and output voltage, current, power, and environmental ranges) for the EVM may cause personal injury or death, or property damage. If there are questions concerning performance ratings and specifications, User should contact a TI field representative prior to connecting interface electronics including input power and intended loads. Any loads applied outside of the specified output range may also result in unintended and/or inaccurate operation and/or possible permanent damage to the EVM and/or interface electronics. Please consult the EVM user guide prior to connecting any load to the EVM output. If there is uncertainty as to the load specification, please contact a TI field representative. During normal operation, even with the inputs and outputs kept within the specified allowable ranges, some circuit components may have elevated case temperatures. These components include but are not limited to linear regulators, switching transistors, pass transistors, current sense resistors, and heat sinks, which can be identified using the information in the associated documentation. When working with the EVM, please be aware that the EVM may become very warm.

4.3.2 EVMs are intended solely for use by technically qualified, professional electronics experts who are familiar with the dangers and application risks associated with handling electrical mechanical components, systems, and subsystems. User assumes all responsibility and liability for proper and safe handling and use of the EVM by User or its employees, affiliates, contractors or designees. User assumes all responsibility and liability to ensure that any interfaces (electronic and/or mechanical) between the EVM and any human body are designed with suitable isolation and means to safely limit accessible leakage currents to minimize the risk of electrical shock hazard. User assumes all responsibility and liability for any improper or unsafe handling or use of the EVM by User or its employees, affiliates, contractors or designees.

4.4 User assumes all responsibility and liability to determine whether the EVM is subject to any applicable international, federal, state, or local laws and regulations related to User's handling and use of the EVM and, if applicable, User assumes all responsibility and liability for compliance in all respects with such laws and regulations. User assumes all responsibility and liability for proper disposal and recycling of the EVM consistent with all applicable international, federal, state, and local requirements.

5. *Accuracy of Information:* To the extent TI provides information on the availability and function of EVMs, TI attempts to be as accurate as possible. However, TI does not warrant the accuracy of EVM descriptions, EVM availability or other information on its websites as accurate, complete, reliable, current, or error-free.

6. *Disclaimers:*
- 6.1 EXCEPT AS SET FORTH ABOVE, EVMS AND ANY WRITTEN DESIGN MATERIALS PROVIDED WITH THE EVM (AND THE DESIGN OF THE EVM ITSELF) ARE PROVIDED "AS IS" AND "WITH ALL FAULTS." TI DISCLAIMS ALL OTHER WARRANTIES, EXPRESS OR IMPLIED, REGARDING SUCH ITEMS, INCLUDING BUT NOT LIMITED TO ANY IMPLIED WARRANTIES OF MERCHANTABILITY OR FITNESS FOR A PARTICULAR PURPOSE OR NON-INFRINGEMENT OF ANY THIRD PARTY PATENTS, COPYRIGHTS, TRADE SECRETS OR OTHER INTELLECTUAL PROPERTY RIGHTS.
- 6.2 EXCEPT FOR THE LIMITED RIGHT TO USE THE EVM SET FORTH HEREIN, NOTHING IN THESE TERMS AND CONDITIONS SHALL BE CONSTRUED AS GRANTING OR CONFERRING ANY RIGHTS BY LICENSE, PATENT, OR ANY OTHER INDUSTRIAL OR INTELLECTUAL PROPERTY RIGHT OF TI, ITS SUPPLIERS/LICENSORS OR ANY OTHER THIRD PARTY, TO USE THE EVM IN ANY FINISHED END-USER OR READY-TO-USE FINAL PRODUCT, OR FOR ANY INVENTION, DISCOVERY OR IMPROVEMENT MADE, CONCEIVED OR ACQUIRED PRIOR TO OR AFTER DELIVERY OF THE EVM.
7. *USER'S INDEMNITY OBLIGATIONS AND REPRESENTATIONS.* USER WILL DEFEND, INDEMNIFY AND HOLD TI, ITS LICENSORS AND THEIR REPRESENTATIVES HARMLESS FROM AND AGAINST ANY AND ALL CLAIMS, DAMAGES, LOSSES, EXPENSES, COSTS AND LIABILITIES (COLLECTIVELY, "CLAIMS") ARISING OUT OF OR IN CONNECTION WITH ANY HANDLING OR USE OF THE EVM THAT IS NOT IN ACCORDANCE WITH THESE TERMS AND CONDITIONS. THIS OBLIGATION SHALL APPLY WHETHER CLAIMS ARISE UNDER STATUTE, REGULATION, OR THE LAW OF TORT, CONTRACT OR ANY OTHER LEGAL THEORY, AND EVEN IF THE EVM FAILS TO PERFORM AS DESCRIBED OR EXPECTED.
8. *Limitations on Damages and Liability:*
- 8.1 *General Limitations.* IN NO EVENT SHALL TI BE LIABLE FOR ANY SPECIAL, COLLATERAL, INDIRECT, PUNITIVE, INCIDENTAL, CONSEQUENTIAL, OR EXEMPLARY DAMAGES IN CONNECTION WITH OR ARISING OUT OF THESE TERMS AND CONDITIONS OR THE USE OF THE EVMS PROVIDED HEREUNDER, REGARDLESS OF WHETHER TI HAS BEEN ADVISED OF THE POSSIBILITY OF SUCH DAMAGES. EXCLUDED DAMAGES INCLUDE, BUT ARE NOT LIMITED TO, COST OF REMOVAL OR REINSTALLATION, ANCILLARY COSTS TO THE PROCUREMENT OF SUBSTITUTE GOODS OR SERVICES, RETESTING, OUTSIDE COMPUTER TIME, LABOR COSTS, LOSS OF GOODWILL, LOSS OF PROFITS, LOSS OF SAVINGS, LOSS OF USE, LOSS OF DATA, OR BUSINESS INTERRUPTION. NO CLAIM, SUIT OR ACTION SHALL BE BROUGHT AGAINST TI MORE THAN ONE YEAR AFTER THE RELATED CAUSE OF ACTION HAS OCCURRED.
- 8.2 *Specific Limitations.* IN NO EVENT SHALL TI'S AGGREGATE LIABILITY FROM ANY WARRANTY OR OTHER OBLIGATION ARISING OUT OF OR IN CONNECTION WITH THESE TERMS AND CONDITIONS, OR ANY USE OF ANY TI EVM PROVIDED HEREUNDER, EXCEED THE TOTAL AMOUNT PAID TO TI FOR THE PARTICULAR UNITS SOLD UNDER THESE TERMS AND CONDITIONS WITH RESPECT TO WHICH LOSSES OR DAMAGES ARE CLAIMED. THE EXISTENCE OF MORE THAN ONE CLAIM AGAINST THE PARTICULAR UNITS SOLD TO USER UNDER THESE TERMS AND CONDITIONS SHALL NOT ENLARGE OR EXTEND THIS LIMIT.
9. *Return Policy.* Except as otherwise provided, TI does not offer any refunds, returns, or exchanges. Furthermore, no return of EVM(s) will be accepted if the package has been opened and no return of the EVM(s) will be accepted if they are damaged or otherwise not in a resalable condition. If User feels it has been incorrectly charged for the EVM(s) it ordered or that delivery violates the applicable order, User should contact TI. All refunds will be made in full within thirty (30) working days from the return of the components(s), excluding any postage or packaging costs.
10. *Governing Law:* These terms and conditions shall be governed by and interpreted in accordance with the laws of the State of Texas, without reference to conflict-of-laws principles. User agrees that non-exclusive jurisdiction for any dispute arising out of or relating to these terms and conditions lies within courts located in the State of Texas and consents to venue in Dallas County, Texas. Notwithstanding the foregoing, any judgment may be enforced in any United States or foreign court, and TI may seek injunctive relief in any United States or foreign court.

Mailing Address: Texas Instruments, Post Office Box 655303, Dallas, Texas 75265
Copyright © 2015, Texas Instruments Incorporated

IMPORTANT NOTICE

Texas Instruments Incorporated and its subsidiaries (TI) reserve the right to make corrections, enhancements, improvements and other changes to its semiconductor products and services per JESD46, latest issue, and to discontinue any product or service per JESD48, latest issue. Buyers should obtain the latest relevant information before placing orders and should verify that such information is current and complete. All semiconductor products (also referred to herein as "components") are sold subject to TI's terms and conditions of sale supplied at the time of order acknowledgment.

TI warrants performance of its components to the specifications applicable at the time of sale, in accordance with the warranty in TI's terms and conditions of sale of semiconductor products. Testing and other quality control techniques are used to the extent TI deems necessary to support this warranty. Except where mandated by applicable law, testing of all parameters of each component is not necessarily performed.

TI assumes no liability for applications assistance or the design of Buyers' products. Buyers are responsible for their products and applications using TI components. To minimize the risks associated with Buyers' products and applications, Buyers should provide adequate design and operating safeguards.

TI does not warrant or represent that any license, either express or implied, is granted under any patent right, copyright, mask work right, or other intellectual property right relating to any combination, machine, or process in which TI components or services are used. Information published by TI regarding third-party products or services does not constitute a license to use such products or services or a warranty or endorsement thereof. Use of such information may require a license from a third party under the patents or other intellectual property of the third party, or a license from TI under the patents or other intellectual property of TI.

Reproduction of significant portions of TI information in TI data books or data sheets is permissible only if reproduction is without alteration and is accompanied by all associated warranties, conditions, limitations, and notices. TI is not responsible or liable for such altered documentation. Information of third parties may be subject to additional restrictions.

Resale of TI components or services with statements different from or beyond the parameters stated by TI for that component or service voids all express and any implied warranties for the associated TI component or service and is an unfair and deceptive business practice. TI is not responsible or liable for any such statements.

Buyer acknowledges and agrees that it is solely responsible for compliance with all legal, regulatory and safety-related requirements concerning its products, and any use of TI components in its applications, notwithstanding any applications-related information or support that may be provided by TI. Buyer represents and agrees that it has all the necessary expertise to create and implement safeguards which anticipate dangerous consequences of failures, monitor failures and their consequences, lessen the likelihood of failures that might cause harm and take appropriate remedial actions. Buyer will fully indemnify TI and its representatives against any damages arising out of the use of any TI components in safety-critical applications.

In some cases, TI components may be promoted specifically to facilitate safety-related applications. With such components, TI's goal is to help enable customers to design and create their own end-product solutions that meet applicable functional safety standards and requirements. Nonetheless, such components are subject to these terms.

No TI components are authorized for use in FDA Class III (or similar life-critical medical equipment) unless authorized officers of the parties have executed a special agreement specifically governing such use.

Only those TI components which TI has specifically designated as military grade or "enhanced plastic" are designed and intended for use in military/aerospace applications or environments. Buyer acknowledges and agrees that any military or aerospace use of TI components which have **not** been so designated is solely at the Buyer's risk, and that Buyer is solely responsible for compliance with all legal and regulatory requirements in connection with such use.

TI has specifically designated certain components as meeting ISO/TS16949 requirements, mainly for automotive use. In any case of use of non-designated products, TI will not be responsible for any failure to meet ISO/TS16949.

Products

Audio	www.ti.com/audio
Amplifiers	amplifier.ti.com
Data Converters	dataconverter.ti.com
DLP® Products	www.dlp.com
DSP	dsp.ti.com
Clocks and Timers	www.ti.com/clocks
Interface	interface.ti.com
Logic	logic.ti.com
Power Mgmt	power.ti.com
Microcontrollers	microcontroller.ti.com
RFID	www.ti-rfid.com
OMAP Applications Processors	www.ti.com/omap
Wireless Connectivity	www.ti.com/wirelessconnectivity

Applications

Automotive and Transportation	www.ti.com/automotive
Communications and Telecom	www.ti.com/communications
Computers and Peripherals	www.ti.com/computers
Consumer Electronics	www.ti.com/consumer-apps
Energy and Lighting	www.ti.com/energy
Industrial	www.ti.com/industrial
Medical	www.ti.com/medical
Security	www.ti.com/security
Space, Avionics and Defense	www.ti.com/space-avionics-defense
Video and Imaging	www.ti.com/video

TI E2E Community

e2e.ti.com